

Vitamin D

Adriana S. Dusso, Alex J. Brown, and Eduardo Slatopolsky

Renal Division, Washington University School of Medicine, St. Louis, Missouri

Dusso, Adriana S., Alex J. Brown, and Eduardo Slatopolsky. Vitamin D. *Am J Physiol Renal Physiol* 289: F8–F28, 2005; doi:10.1152/ajprenal.00336.2004.—The vitamin D endocrine system plays an essential role in calcium homeostasis and bone metabolism, but research during the past two decades has revealed a diverse range of biological actions that include induction of cell differentiation, inhibition of cell growth, immunomodulation, and control of other hormonal systems. Vitamin D itself is a prohormone that is metabolically converted to the active metabolite, 1,25-dihydroxyvitamin D [1,25(OH)₂D]. This vitamin D hormone activates its cellular receptor (vitamin D receptor or VDR), which alters the transcription rates of target genes responsible for the biological responses. This review focuses on several recent developments that extend our understanding of the complexities of vitamin D metabolism and actions: the final step in the activation of vitamin D, conversion of 25-hydroxyvitamin D to 1,25(OH)₂D in renal proximal tubules, is now known to involve facilitated uptake and intracellular delivery of the precursor to 1 α -hydroxylase. Emerging evidence using mice lacking the VDR and/or 1 α -hydroxylase indicates both 1,25(OH)₂D₃-dependent and -independent actions of the VDR as well as VDR-dependent and -independent actions of 1,25(OH)₂D₃. Thus the vitamin D system may involve more than a single receptor and ligand. The presence of 1 α -hydroxylase in many target cells indicates autocrine/paracrine functions for 1,25(OH)₂D₃ in the control of cell proliferation and differentiation. This local production of 1,25(OH)₂D₃ is dependent on circulating precursor levels, providing a potential explanation for the association of vitamin D deficiency with various cancers and autoimmune diseases.

vitamin D metabolism; vitamin D receptor; calcium homeostasis; transcriptional regulation; rapid steroid actions

VITAMIN D, DISCOVERED AS AN essential nutrient for the prevention of rickets, is required for optimal absorption of dietary calcium and phosphate. Subsequent studies found that rickets could also be prevented by irradiation with UV light, which stimulates formation of vitamin D₃ by the skin. This ability to produce sufficient amounts of vitamin D₃ with adequate sunlight exposure indicates that vitamin D is actually not a vitamin. It is now appreciated that vitamin D is metabolized to the steroid hormone 1,25-dihydroxyvitamin D₃ [1,25(OH)₂D₃] or calcitriol. The earlier observation that metabolites of vitamin D interact with a protein in intestinal extracts led to the identification of the vitamin D receptor (VDR), a member of the steroid receptor superfamily. The VDR is a 1,25(OH)₂D₃-activated transcription factor that interacts with coregulators and the transcriptional preinitiation complex to alter the rate of target gene transcription. The presence of the VDR in tissues that do not participate in mineral ion homeostasis led to the discovery of a host of other functions for the versatile vitamin D hormone. The ability of 1,25(OH)₂D₃ to inhibit growth and promote differentiation of a variety of cell types has suggested diverse functions in preventing cancers, modulating the immune system, and controlling various endocrine systems. This is in keeping with epidemiological evidence associating vita-

min D deficiency with cancer, autoimmune diseases, hypertension, and diabetes.

The present review focuses on recent developments in our understanding of the vitamin D endocrine system, including 1) mechanisms for facilitated delivery of vitamin D metabolites, 2) the apparent 1,25(OH)₂D₃-independent effects of the VDR and VDR-independent effects of 1,25(OH)₂D₃, and 3) the emerging importance of the autocrine/paracrine actions of 1,25(OH)₂D₃.

VITAMIN D METABOLISM

Vitamin D Bioactivation

Vitamin D can be obtained from the diet and by the action of sunlight on the skin. Exposure of the skin to the UV rays of sunlight induces the photolytic conversion of 7-dehydrocholesterol to previtamin D₃ followed by thermal isomerization to vitamin D₃ (115, 186). Only a few natural food sources contain significant amounts of vitamins D₂ and D₃, but many foods are now fortified with vitamin D. Nonetheless, vitamin D insufficiency persists in most of the world including North America and Europe (48, 236) due to nutritional deficit and perhaps to avoidance of sunlight and the use of sunscreens. This is a major concern because, as discussed below, low vitamin D is associated with many diseases including cancer, autoimmune disease, and hypertension.

The first step in the metabolic activation of vitamin D is hydroxylation of carbon 25, which occurs primarily in the liver (Fig. 1). Several hepatic cytochrome P-450s have been shown

Address for reprint requests and other correspondence: E. Slatopolsky, Dept. of Internal Medicine, Washington University School of Medicine, Campus Box 8126, 660 S. Euclid Ave., St. Louis, MO 63110-1093 (E-mail: eslatopo@im.wustl.edu).

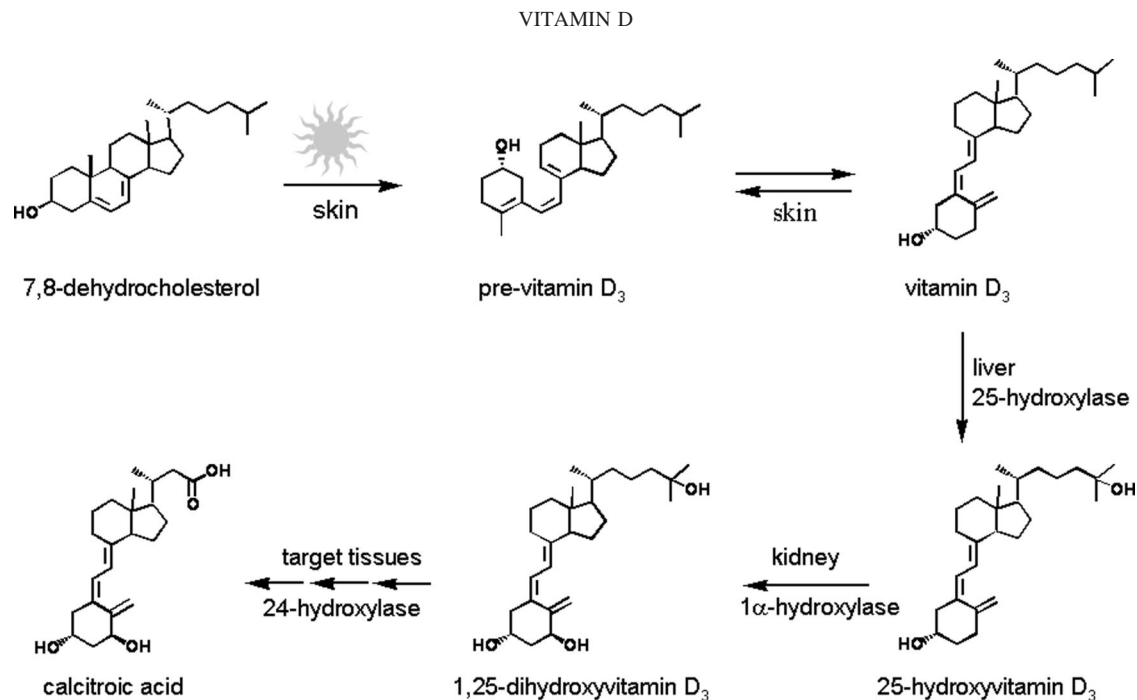

Fig. 1. Vitamin D₃ synthesis, activation, and catabolism. Vitamin D₃ is produced in the skin by the photolytic cleavage of 7-dehydrocholesterol followed by thermal isomerization. Vitamin D is transported to the liver via the serum vitamin D binding protein, where it is converted to 25-hydroxyvitamin D₃, the major circulating metabolite of vitamin D₃. The final activation step, 1 α -hydroxylation, occurs primarily, but not exclusively, in the kidney (see text), forming 1,25-dihydroxyvitamin D₃, the hormonal form of the vitamin. Catabolism/inactivation is carried out by 24-hydroxylase, which catalyzes a series of oxidation steps resulting in side chain cleavage.

to 25-hydroxylate vitamin D compounds, but three of these have been excluded as candidates: CYP2C11 is expressed only in males rats (103) and not in humans (204), CYP27A1 knockouts have normal vitamin D levels (201), and CYP3A4 does not hydroxylate vitamin D₃ (99). On the other hand, CYP2R1 appears to be a good candidate. This previously orphan cytochrome *P*-450 was shown to 25-hydroxylate both vitamin D₃ and vitamin D₂, to be present mainly in the liver and testis (56), and mutations in the 2R1 gene have been identified in a patient with low 25-hydroxyvitamin D levels and rickets (55). Thus CYP2R1 appears to be the critical 25-hydroxylase involved in vitamin D metabolism. The 25-hydroxylation of vitamin D is poorly regulated. The levels of 25(OH)D increase in proportion to vitamin D intake and, for this reason, plasma 25(OH)D levels are commonly used as an indicator of vitamin D status (113).

The second step in vitamin D bioactivation, the formation of 1 α ,25-dihydroxyvitamin D [1,25-(OH)₂D] from 25-hydroxyvitamin D, occurs under physiological conditions, mainly in the kidney (86) (Fig. 1), but other cell types can contribute to circulating levels in specific conditions (pregnancy, chronic renal failure, sarcoidosis, tuberculosis, granulomatous disorders, and rheumatoid arthritis). However, the extrarenally produced 1,25(OH)₂D primarily serves as an autocrine/paracrine factor with cell-specific functions, as discussed below. To date, 1 α -hydroxylase has been reported in many cells and tissues including the prostate, breast, colon, lung, pancreatic β cells, monocytes, and parathyroid cells (see Fig. 2) (109).

The 1 α -hydroxylase gene has been cloned from several species (90, 169, 220, 225, 233). The cDNA hybridizes solely to chromosomal locus 12q13.1-q13.3, the site to which the defect in patients unable to produce 1,25(OH)₂D₃ (vitamin D-dependent rickets type I or VDDR-I) has been mapped

(145), and mutations in the coding regions of the 1 α -hydroxylase gene have been identified in patients with the disease (90, 136, 258). Targeted ablation of 1 α -hydroxylase in mice produced a phenotype consistent with VDDR-I (66, 191).

Renal 1 α -hydroxylase activity is highly regulated, in keeping with the potent activity of its product in calcium homeostasis. Dietary calcium can regulate the enzyme directly through changes in serum calcium and indirectly by altering parathyroid hormone (PTH) levels (188). The stimulation of 1 α -hydroxylase by hypocalcemia is severely blunted, but not eliminated, by parathyroidectomy (92). Direct suppression of 1 α -hydroxylase activity and mRNA by calcium has been

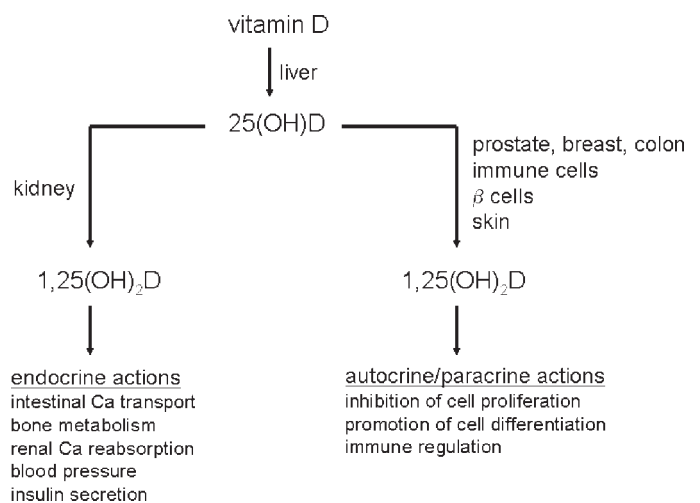

Fig. 2. Renal and extrarenal 1,25(OH)₂D₃ production serves endocrine, autocrine, and paracrine functions.

demonstrated in a human proximal tubule cell line (27). It is not yet known whether this effect is mediated by the calcium-sensing receptor (CaSR). PTH has been shown to directly regulate 1α -hydroxylase activity (107) and mRNA (220, 225) in renal proximal tubular cells via changes in cAMP (202) through stimulation of 1α -hydroxylase gene transcription (35, 173). Although the promoter for 1α -hydroxylase contains three consensus cAMP response elements (CREs), PTH appears to exert its effect through actions at an element near the transcription start site which lacks a CRE, but contains a binding site for the transcription factor C/EBP β (207).

Dietary phosphate restriction also increases renal 1α -hydroxylase activity (235) and mRNA (220) independently of changes in PTH (120) and calcium (46). The lack of a direct effect of phosphate on 1α -hydroxylase in cell culture suggests that the effect of dietary phosphate may be mediated by a systemic hormone. Likely candidates are the recently discovered phosphaturic factors or phosphatonins, fibroblast growth factor 23 (FGF-23), frizzled-related protein 4 (FRP-4), and matrix extracellular phosphoglycoprotein (MEPE) (reviewed in Ref. 209). FGF-23 reduces renal phosphate reabsorption by inhibition of NPT2. Recent evidence indicates that FGF-23 is increased by phosphate loading, suggesting a role in phosphate homeostasis. Of relevance is that transgenic mice constitutively expressing FGF-23 have reduced $1,25(\text{OH})_2\text{D}_3$ levels despite low plasma phosphate (219). FRP-4 administration was found to produce hypophosphatemia, but $1,25(\text{OH})_2\text{D}_3$ levels and 1α -hydroxylase did not increase appropriately, suggesting a suppressive effect of FRP-4 on $1,25(\text{OH})_2\text{D}_3$ production (22). Similarly, MEPE overexpression in vivo produces hypophosphatemia and reduction of $1,25(\text{OH})_2\text{D}_3$ levels (203). Thus all of the phosphatonins appear to alter circulating $1,25(\text{OH})_2\text{D}_3$, perhaps acting as mediators of phosphate regulation of 1α -hydroxylase.

Feedback regulation by $1,25(\text{OH})_2\text{D}_3$ limits its circulating levels to minimize the potential for vitamin D intoxication. Although the in vivo effects are due, in part, to increased calcium and phosphate and decreased PTH, direct suppression of 1α -hydroxylase activity has been noted in kidney cell culture (106, 238). $1,25(\text{OH})_2\text{D}_3$ treatment has been shown to reduce 1α -hydroxylase mRNA (169, 220, 225, 233); however, current evidence indicates that this is not through a direct action of $1,25(\text{OH})_2\text{D}_3$ and its receptor on the 1α -hydroxylase gene promoter, but inhibition of the PTH (cAMP) induction of promoter activity (35).

Another factor that appears to control renal $1,25(\text{OH})_2\text{D}_3$ production is the *klotho* gene product. *Klotho*-null mice have elevated $1,25(\text{OH})_2\text{D}_3$ levels, high plasma calcium and phosphate, and die prematurely due to ectopic calcifications (257). Basal 1α -hydroxylase mRNA is increased despite the hypercalcemia, hyperphosphatemia, and low PTH (239), indicating that the *klotho* gene product is a negative regulator of 1α -hydroxylase. The fact that *klotho* is also induced by $1,25(\text{OH})_2\text{D}_3$ (239) suggests that it may be involved in the feedback control of $1,25(\text{OH})_2\text{D}_3$ on its own production.

The regulation of 1α -hydroxylase at extrarenal sites is quite different from that of the renal enzyme, in keeping with the autocrine/paracrine functions of locally produced $1,25(\text{OH})_2\text{D}_3$. The rates of $1,25(\text{OH})_2\text{D}_3$ synthesis and degradation are under the control of local factors, i.e., cytokines and growth factors, that optimize the levels of $1,25(\text{OH})_2\text{D}_3$ for

these cell-specific actions through mechanisms incompletely understood.

1,25(OH)₂D₃ Metabolism

The high potency of $1,25(\text{OH})_2\text{D}_3$ in elevating serum calcium and phosphate levels requires a mechanism to attenuate its activity. This is accomplished within virtually all target cells by the $1,25(\text{OH})_2\text{D}_3$ -inducible vitamin D 24-hydroxylase, which catalyzes a series of oxidation reactions at carbons 24 and 23, leading to side chain cleavage and inactivation. Mice lacking a functional 24-hydroxylase gene have high serum $1,25(\text{OH})_2\text{D}_3$ levels due to the decreased capacity to degrade it (224). 24-Hydroxylase is regulated in a reciprocal manner to 1α -hydroxylase. Its activity and expression are increased by phosphate (235, 252) and reduced by PTH (107). The 24-hydroxylase gene contains at least two distinct vitamin D response elements that mediate the effects of $1,25(\text{OH})_2\text{D}_3$ via its receptor on transcription (54, 185).

$1,25(\text{OH})_2\text{D}_3$ can also be converted to the $1,25(R)$ - $(\text{OH})_2\text{D}_3$ -23(*S*),26-lactone (124). This metabolite has mild antagonist activity toward $1,25(\text{OH})_2\text{D}_3$ action (123), and more potent lactone analogs have now been developed. Recent studies have demonstrated that the 3β -hydroxyl group of $1,25(\text{OH})_2\text{D}_3$ can be epimerized to the 3α position (26, 39) in a cell-specific manner. $1,25(\text{OH})_2$ -3-epi- D_3 appears to be catabolized more slowly than the parent hormone and retains significant biological activity. The significance of the 3-epimerase is not clear, but its cell-specific expression suggests that this pathway may function to prolong the activity of $1,25(\text{OH})_2\text{D}_3$ in cells containing this enzyme. Differential rates of 3-epimerization of vitamin D analogs may provide a mechanism for their selective actions in vivo. In addition, evidence suggests that 3-epimerization of select vitamin D analogs may enhance their proapoptotic activity (174).

TRANSPORT OF VITAMIN D

Vitamin D metabolites are lipophilic molecules with low aqueous solubility that must be transported in the circulation bound to plasma proteins. The most important of these carrier proteins is the vitamin D binding protein (DBP), which binds the metabolites with high affinity in the order $25(\text{OH})\text{D} = 24,25(\text{OH})_2\text{D} > 1,25(\text{OH})_2\text{D} > \text{vitamin D}$ (61). Plasma levels of DBP are 20 times higher than the total amount of vitamin D metabolites, and >99% of circulating vitamin D compounds are protein bound, mostly to DBP, although albumin and lipoproteins contribute to lesser degrees. This has a major impact on their pharmacokinetics. DBP-bound vitamin D metabolites have limited access to target cells (61) and, therefore, are less susceptible to hepatic metabolism and subsequent biliary excretion, leading to a longer circulating half-life. Early evidence suggested that only the small fraction of unbound metabolites passively entered target cells to be further metabolized or to exert biological activity. For activated vitamin D compounds [i.e., $1,25(\text{OH})_2\text{D}_3$ and its analogs], biological activity was correlated with the concentration of free hormone (23, 37, 73). Thus DBP appears to buffer the free levels of active vitamin D compounds, guarding against vitamin D intoxication (30). DBP levels are not regulated by vitamin D but are reduced by liver disease, nephrotic syndrome, and malnutrition and increased during pregnancy and estrogen

therapy. The concentration of free $1,25(\text{OH})_2\text{D}_3$, however, remains constant when DBP levels change, an example of the tight self-regulation of vitamin D metabolism. In fact, DBP-null mice lack any indications of rickets, despite very low total levels of $25(\text{OH})\text{D}$ and $1,25(\text{OH})_2\text{D}$, supporting the free hormone hypothesis for the actions of $1,25(\text{OH})_2\text{D}_3$ and its analogs.

On the other hand, it is now clear that $25(\text{OH})\text{D}$ does not simply diffuse into the proximal tubule cells containing 1α -hydroxylase. Mice lacking the endocytic receptor megalin were unexpectedly found to develop vitamin D deficiency and rickets due to a loss of DBP and its bound vitamin D metabolites in the urine (183, 232). Thus entry of $25(\text{OH})\text{D}$ into the proximal tubule cells is not by diffusion across the basolateral surface but by receptor-mediated uptake of DBP in the brush border, as depicted in Fig. 3. This mechanism explains the finding that DBP-null mice are resistant to vitamin D intoxication (205). However, because DBP-null mice do not display vitamin D deficiency, DBP-independent uptake of $25(\text{OH})\text{D}$ must also occur. Megalin is part of a complex of proteins that facilitate endocytosis. Receptor-associated protein (RAP) is also essential as its ablation leads to excretion of DBP (25) as does the removal of cubilin (184), a protein required for sequestering DBP on the cell surface before internalization by megalin.

Once inside the cells, DBP is degraded, apparently by legumain (255), releasing $25(\text{OH})\text{D}$ for metabolism by 1α -hydroxylase or 24 -hydroxylase; however, $25(\text{OH})\text{D}$ translocation to the mitochondria may also be facilitated rather than passive. It was recently reported that the intracellular COOH terminus of megalin interacts with at least two intracellular vitamin D binding proteins, IDBP-1 and IDBP-3 (2). IDBPs are homologs of heat shock proteins that bind 25 -hydroxylated vitamin D compounds as well as estradiol (91) and may serve diverse roles. Overexpression of IDBP-3 in cells expressing megalin increases the movement of $25(\text{OH})\text{D}$ to the mitochondria for hydroxylation (Fig. 2). In fact, IDBP-3 appears to interact directly with 1α -hydroxylase. On the other hand, IDBP-1 overexpression enhances movement of $1,25(\text{OH})_2\text{D}_3$ to the VDR. Megalin has also been shown to bind the VDR coactivator SKI-

interacting protein (Skip), suggesting another means of controlling vitamin D action (196).

Megalin levels are increased by $1,25(\text{OH})_2\text{D}_3$ (155), providing a feed-forward mechanism for $1,25(\text{OH})_2\text{D}_3$ production. Partial ($3/4$) nephrectomy of rats leads to a gradual fall in megalin expression in the remnant kidney beginning within 2 wk, which is followed later by an increase in 1α -hydroxylase mRNA. This apparently compensates for the reduced megalin levels and the decreased synthetic capacity due to the loss of renal mass (232). This finding further supports the importance of vitamin D supplementation of patients with early renal failure.

$1,25(\text{OH})_2\text{D}_3$ -VDR ACTIONS

Most of the biological activities of $1,25(\text{OH})_2\text{D}_3$ require a high-affinity receptor, the VDR, an ancient member of the superfamily of nuclear receptors for steroid hormones. Like the other members of the steroid receptor family, the VDR acts as a ligand-activated transcription factor (36). Figure 4 depicts the domains of the VDR involved in the major steps for VDR control of gene transcription: 1) ligand binding, 2) heterodimerization with retinoid X receptor (RXR), 3) binding of the heterodimer to vitamin D response elements (VDREs) in the promoter of $1,25(\text{OH})_2\text{D}$ -responsive genes, and 4) recruitment of VDR-interacting nuclear proteins (coregulators) into the transcriptional preinitiation complex, which markedly enhance or suppress the rate of gene transcription by the VDR.

The ligand binding domain (LBD), located in the COOH-terminal portion of the VDR molecule, is responsible for the high-affinity binding of $1,25(\text{OH})_2\text{D}_3$ ($K_d = 10^{-10}$ to 10^{-11} M). $25(\text{OH})\text{D}_3$ and $24,25(\text{OH})_2\text{D}_3$ bind nearly 100 times less avidly (44, 167). The A ring containing the 1α -hydroxyl group is a critical portion of the $1,25(\text{OH})_2\text{D}_3$ molecule responsible for VDR binding. However, other domains of the VDR are important, as shown by their capacity to compensate for the lack of a functional 1α -hydroxyl group (194). Ligand binding affinity, however, is not an absolute predictor of the transcriptional activity of ligand-activated VDR. Cell-specific variations in the expression of intracellular binding proteins that mediate the delivery of the ligand to and from the VDR may

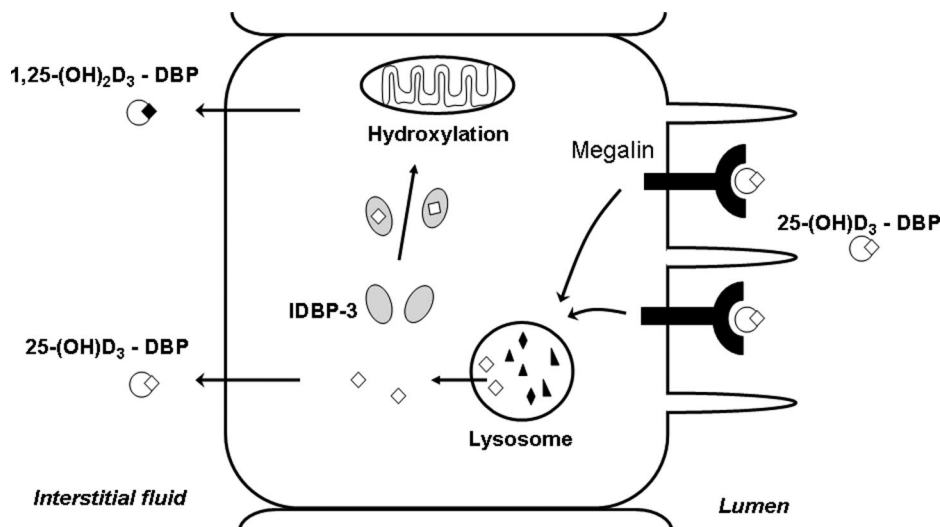

Fig. 3. Roles of megalin and intracellular vitamin D binding protein 3 (IDBP-3) in the delivery and 1α -hydroxylation of 25 -hydroxyvitamin D. The majority of circulating 25 -hydroxyvitamin D is bound to the vitamin D binding protein (DBP), which is filtered by the kidney and taken up by proximal tubular cells via megalin-mediated endocytosis. The DBP is degraded, and the released 25 -hydroxyvitamin D is delivered to the 1α -hydroxylase by IDBP-3 or reenters the circulation bound to DBP. Modified from Ref. 183.

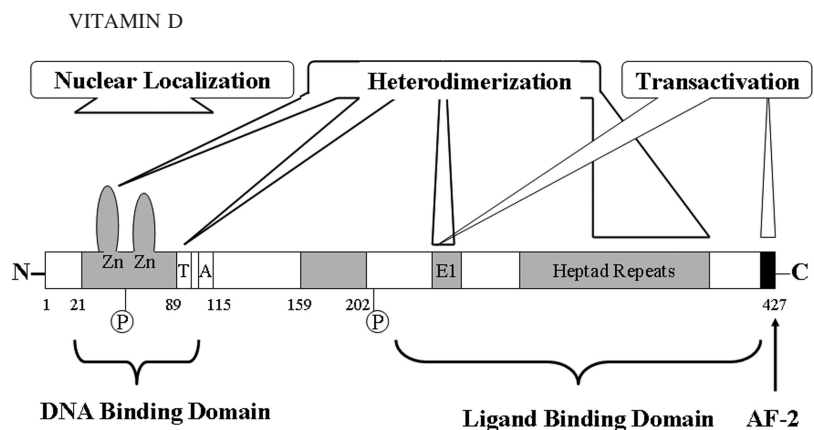

Fig. 4. Functional domains of the vitamin D receptor (VDR). Shown is a schematic representation of the domains of the human VDR molecule mediating ligand and DNA binding, nuclear localization, heterodimerization with the retinoid X receptor (RXR), and transactivation, as well as the 2 major phosphorylation sites. AF-2, activation function-2.

modulate ligand-VDR association/dissociation rates (138) and, consequently, the half-life of the VDR molecule, which is protected from proteosomal degradation (162) through ligand binding (249).

Upon ligand binding, repositioning of helix 12 in the COOH terminus of the VDR ligand binding domain, known as ligand-dependent activation function 2 (AF2), imparts a major conformational change in the three-dimensional structure of the VDR. This activation step appears to be required for the recruitment by the VDR of motor proteins (200), responsible for a rapid translocation of cytoplasmic VDR to the nucleus along microtubules (19). In human monocytes, disruption of microtubular integrity is sufficient to abolish $1,25(\text{OH})_2\text{D}_3$ induction of 24-hydroxylase gene transcription (129). Point mutations in the two nuclear localization signals cause a defective cytoplasmic-to-nuclear translocation and the phenotype of vitamin D-dependent rickets type II (20, 108).

The selective association between the VDR and its protein partner, the RXR, involves dimerization surfaces in three different domains of the VDR molecule and induces a VDR conformation that is essential for VDR transactivating function. An interplay between ligand binding and heterodimerization domains was suggested by two natural mutations (I314S and R391C) in the LBD of the VDR that confer the phenotype of vitamin D resistance by significantly impairing both VDR-RXR heterodimerization and ligand retention (101).

The DNA-binding domain (DBD) of the VDR is highly conserved among nuclear steroid receptors. The DBD is organized into two zinc-nucleated modules, the zinc finger DNA binding motifs, that are responsible for high-affinity interaction with specific DNA sequences in the promoter region of $1,25(\text{OH})_2\text{D}_3$ target genes, called vitamin D-responsive elements (VDREs). The natural mutations in the zinc finger region of the human VDR result in defective DNA binding and the most severe clinical phenotypes of vitamin D resistance (102). High-resolution crystal structures show the DBD of the VDR bound to the major groove of the hexameric VDRE (217). VDR-RXR binding to VDREs causes a 55° bending of the DNA from the horizontal, but the impact of this DNA bending on VDR-mediated transactivation is unclear (227). The most common VDRE type, designated DR3, contains two variable, six-base half-elements with the general consensus sequence AGGTCA, separated by a spacer of three nucleotides. This sequence directs the VDR-RXR heterodimer to the promoter region of $1,25(\text{OH})_2\text{D}_3$ -regulated genes, with the RXR binding the 5' half-site and the VDR occupying the 3'

half-site (102). Another type of VDRE, IP9, consists of two inverted palindromic sequences separated by nine base pairs (210). The VDREs of genes suppressed by the VDR, such as chick PTH and mouse osteocalcin, are similar to the DR3 sequence found in genes in which transcription is induced by vitamin D. This finding raised important questions regarding the mechanisms determining whether gene transcription will be induced or suppressed by $1,25(\text{OH})_2\text{D}_3$ (67). The switch from VDR transrepression to activation of the avian PTH gene, induced by changing two bases in the 5'-element of the DR3, suggested that a changed polarity of the VDR/RXR-VDRE complex, with the VDR occupying the 5' half-element, may contribute to VDR-negative regulation of gene transcription (102).

Recently discovered VDR interactions with nuclear coregulator molecules provide new mechanistic insights into positive and negative modulation of VDR-mediated transcription. Two domains of the VDR serve as adaptor surfaces for nuclear proteins necessary for VDR-coregulator interactions (51): one is the RXR heterodimerization domain containing residue 246, which is highly conserved among nuclear receptors, and forms part of the binding interface with transcriptional coactivators. Its alteration severely compromises transactivation. The second region is the previously described AF2 domain, which undergoes a dramatic conformational shift on ligand binding, allowing the recruitment of VDR-interacting proteins including components of the transcription initiation complex, RNA polymerase II, and nuclear transcriptional coactivators that promote chromatin remodeling and gene transcription. Removal of the AF2 domain eliminates $1,25(\text{OH})_2\text{D}_3$ -VDR transcriptional activity with little effect on ligand binding or heterodimeric DNA binding. Nuclear coactivators act synergistically with the VDR to markedly amplify $1,25(\text{OH})_2\text{D}_3$ gene-transactivating potency. The VDR-nuclear coactivators SRC-1 and CBP/p300 possess histone acetyl transferase activity, which unfolds and exposes the DNA. This allows the recruitment of a second complement of transcriptional coactivators, the DRIP-TRAP complex of ~ 15 proteins. DRIP205 interacts directly with the VDR. DRIP-TRAP recruitment builds a bridge with the basal transcriptional machinery that favors the assembly of the preinitiation complex to potentiate VDR induction of gene expression (128, 199).

In transcriptional repression by the VDR, such as that of the PTH gene, binding of the VDR-RXR complex to a negative VDRE recruits corepressors of the family of histone deacetylases. These molecules prevent chromatin exposure, and con-

sequently, the binding of proteins (TATA binding protein) mandatory to initiate the transcription of the target gene by RNA-polymerase II (128, 199). In vitro, ligand-specific recruitment of more potent VDR corepressors to the PTH gene promoter appears to mediate a higher transrepression potency for 22-oxa-calcitriol compared with 1,25(OH)₂D₃ (234). In primary cultures of bovine parathyroid cells, however, differences between OCT and 1,25(OH)₂D₃ potency in repressing rat PTH mRNA levels were not apparent (40).

Recent studies suggest a bifunctional role for the VDR comodulator NCoA62/Skip. It can promote transcriptional activation or repression, in a cell-specific manner, depending on the expression of coregulator molecules (147). The coactivator p300 and the corepressors NCoR and SMRT interact with the same NH₂-terminal region of the Skip molecule. The relative levels of expression of the nuclear corepressor NCoR and coactivator CBP/p300 in CV-1 and P19 cells dictate whether Skip activates or represses VDR/RXR-dependent transcription (147). More importantly, the 1,25(OH)₂D₃-VDR complex induces selectively the expression of genes of two important coregulator families, TIF2 from the p160 coactivators and SMRT among corepressors (72). Because SRC1/TIF2 ratios were shown to affect important cellular functions, such as energy metabolism in murine fat tissue (197), the apparent cell specificity of the 1,25(OH)₂D₃-VDR complex in inducing gene transcription and possibly protein abundance of TIF2 and SMRT suggests that 1,25(OH)₂D₃ itself could modulate the transcriptional competence of target cells.

In addition to Skip, a novel ATP-dependent chromatin remodeling complex containing the Williams syndrome transcription factor potentiates ligand-induced VDR action in both gene transactivation and repression (131).

NCoA62/Skip also mediates a link between transcriptional regulation by the VDR (and other nuclear receptors) and RNA splicing by the spliceosome (262). Skip physically interacts with components of the splicing machinery and nuclear matrix-associated proteins. In fact, expression of a dominant negative Skip interfered with appropriate splicing of transcripts derived from 1,25(OH)₂D₃-VDR transactivation (262).

In summary, complex cell- and promoter-specific VDR-nuclear coregulator interactions are responsible for VDR regulation of the expression of vitamin D-responsive genes, including VDR coactivator and corepressor molecules.

RAPID NONGENOMIC ACTIONS OF 1,25(OH)₂D₃

Vitamin D compounds, like other steroid hormones, can also elicit responses that are too rapid to involve changes in gene expression and appear to be mediated by cell surface receptors. The role of the nongenomic actions in most cells remains uncertain. In the chick duodenum, 1,25(OH)₂D₃ stimulates vesicular calcium movement from the lumen to the basolateral surface within minutes (180), but the overall contribution of this pathway is not clear. 1,25(OH)₂D₃ can rapidly stimulate phosphoinositide metabolism (32, 153, 170), cytosolic calcium levels (116, 152, 159, 170, 228), cGMP levels (98, 245), PKC (230), MAP kinases (21, 222), and the opening of chloride channels (260). In chondrocytes, nongenomic actions of both 1,25(OH)₂D₃ and 24,25(OH)₂D₃ alter membrane lipid turnover, prostaglandin production, and protease activity that leads to modification of bone matrix and calcification (33).

The nature of the receptor that mediates the rapid actions remains controversial. At least two distinct receptors have been identified. The better characterized is the membrane-associated, rapid-response steroid-binding protein (1,25D₃-MARRS) isolated from chick intestinal basolateral membranes on the basis of 1,25(OH)₂D₃ binding (177). Antibodies to the NH₂-terminal domain of 1,25D₃-MARRS blocked the nongenomic actions of 1,25(OH)₂D₃ (179). 1,25D₃-MARRS has now been found to be identical to the protein thiol-dependent oxidoreductase ERp57 (178), which plays a role in glycoprotein folding through the formation of disulfide bonds and acts as part of a chaperone complex with calreticulin and calnexin (78). ERp57 ribozyme knockdown reduced membrane binding of 1,25(OH)₂D₃ and rapid responses (178), but how this enzyme mediates the rapid actions of 1,25(OH)₂D₃ remains to be determined. Another 1,25(OH)₂D₃-binding protein, annexin II, was identified in the plasma membranes of ROS 24/1 rat osteosarcoma cells that do not express the VDR (14). Polyclonal antibodies to annexin II decreased binding of 1,25(OH)₂-[¹⁴C]D₃ and blocked the increase in cytosolic calcium by 1,25(OH)₂D₃ (16). However, a recent report could not reproduce the 1,25(OH)₂D₃ binding to annexin II (168). The rapid actions of 24,25(OH)₂D₃ in chondrocytes appear to be mediated by a receptor distinct from those for 1,25(OH)₂D₃, although its identity is not known.

Several studies have indicated that the rapid actions of 1,25(OH)₂D₃ require the presence of the VDR. The apparent nongenomic actions of 1,25(OH)₂D₃ are absent in cells isolated from VDR-null mice (81, 261), and it has been proposed that the VDR mediates these rapid effects. Furthermore, the VDR was recently found to be present in caveolae-enriched plasma membrane fractions (121). However, the ligand specificities of the VDR and the rapid action receptor are very different (29, 182, 263), and 1,25(OH)₂D₃ cannot stimulate transcaltachia in vitamin D-deficient chick duodenum. This would suggest that the VDR is required for the expression of gene products involved in the rapid, nongenomic response. The exact role of the VDR in the rapid actions remains to be clarified.

Nongenomic events have been proposed to modulate the genomic actions of 1,25(OH)₂D₃ (15, 17, 85), but this remains controversial. Numerous studies have presented evidence that the nongenomic actions may not be critical for 1,25(OH)₂D₃-mediated gene activation (84, 127, 134, 135, 181, 264) or inhibition of cell proliferation (105, 181). However, nongenomic stimulation of protein kinases could potentially influence the VDR-mediated effects of 1,25(OH)₂D₃.

REGULATION OF 1,25(OH)₂D₃-VDR ACTIONS

The magnitude of a biological VDR-mediated response to 1,25(OH)₂D₃ is influenced by ligand accessibility to the VDR, cellular VDR content, genetic and posttranslational VDR modifications, and availability and activation state of nuclear coregulators, as depicted in Fig. 5.

Intracellular Ligand and VDR Content

As described in prior sections, the concentration of ligand in a target cell available for VDR binding is determined by the net balance between the rate of uptake of ligand into the cell and the rate of its metabolic inactivation within the cell. The reduced 1,25(OH)₂D₃ clearance and signs of vitamin D intox-

Fig. 5. Current model for the control of vitamin D receptor (VDR)-mediated actions of $1,25(\text{OH})_2\text{D}_3$. The bioactivated vitamin D hormone, $1,25(\text{OH})_2\text{D}_3$, circulates bound to the DBP. $1,25(\text{OH})_2\text{D}_3$ taken up by target cells is either targeted by IDBPs to mitochondrial 24-hydroxylase or to the VDR. The $1,25(\text{OH})_2\text{D}_3$ -VDR complex heterodimerizes with RXR, and the VDR/RXR heterodimer binds specific sequences in the promoter regions of the target gene. The DNA-bound heterodimer attracts components of the RNA polymerase II (Pol II) preinitiation complex and nuclear transcription regulators, thereby altering the rate of gene transcription. The $1,25(\text{OH})_2\text{D}_3$ -VDR complex interaction with SUG1 targets the VDR for proteasomal degradation. Calreticulin interaction with the DNA-binding domain of the VDR sequesters the VDR, preventing transactivation. TF, transcription factors.

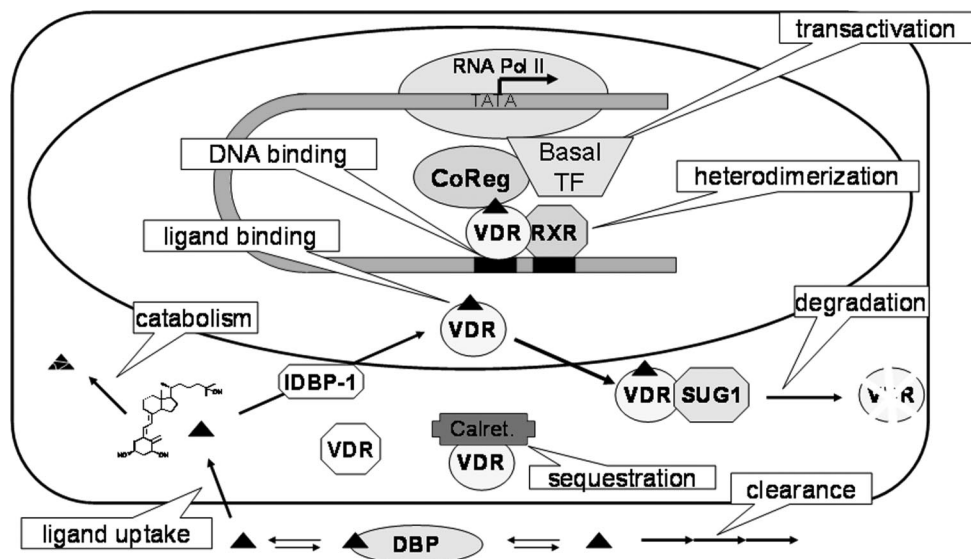

ication in the 24-hydroxylase-null mice provide conclusive evidence of the critical role of ligand inactivation in the in situ control of the response to vitamin D (226).

In addition to the actual content of intracellular ligand, the levels of intracellular vitamin D interacting proteins (IDBPs) may modulate ligand-VDR association/dissociation rates and therefore ligand-dependent VDR activation, in a cell-specific manner. A differential expression of IDBPs could partially account for the VDR-binding saturation for the vitamin D analog 22-oxacalcitriol. A much lower concentration of the ligand leads to VDR saturation in the parathyroid glands compared with other tissues, all expressing an identical VDR molecule (138).

The intracellular levels of VDR in a target cell are regulated by VDR ligands (homologous regulation) (63) and other hormones and growth factors that do not bind to the VDR (heterologous upregulation), with profound species-, tissue-, and cell-specific variations in VDR regulation (36).

$1,25(\text{OH})_2\text{D}_3$ upregulates VDR mRNA in the kidney and the parathyroid glands through an unknown mechanism, because there is no VDRE in the VDR promoter for direct transactivation of the VDR gene. On the other hand, $1,25(\text{OH})_2\text{D}_3$ induction of VDR protein occurs in virtually all cell types (9) and involves ligand-dependent stabilization of the VDR from proteosomal degradation. Physical interactions of liganded VDR with SUG1, a component of the proteasome complex, targets the VDR for ubiquitination and subsequent proteolysis (162), thus providing an in situ control of transcriptional responses to $1,25(\text{OH})_2\text{D}_3$. In fact, a reduced recruitment of SUG1 to the VDR by $1,25(\text{OH})_2\text{D}_3$ analogs accounts for their higher transactivating potency (125). It is unclear what targets the liganded VDR to the proteasome or the transcriptional preinitiation complex.

VDR Polymorphisms

Many allelic variants (polymorphisms) of the chromosome 12 VDR gene occur naturally in the human population (142, 172), with substantial differences between races and ethnic groups (240). Their expression associates with decreased bone density (76), propensity to hyperparathyroidism

(52, 94), resistance to vitamin D therapy (141), and susceptibility to infections, autoimmune diseases, and cancer (241). The polymorphisms most frequently studied are located in the intron separating exon VIII and IX and were defined by the restriction enzymes *BsmI*, *ApaI*, and *TaqI*. In most epidemiological studies, however, correlations were sought between a single specific polymorphism, or between the *BsmI-ApaI-TaqI* linkage group and the physiological parameter of interest (248), and lack analysis of the direct influence of allelic variation on VDR protein expression or activity. In fact, *BsmI*, *ApaI*, or *TaqI* alleles have no effect on either the expression levels or the activity of the translated VDR protein. These are important limitations that leave open the possibility that the observed correlations might be due to another nearby site or even to a different gene.

Several functional VDR polymorphisms exist: 1) linked to the *Apa*, *Bsm*, and *Taq* polymorphisms is a microsatellite poly A repeat of variable length [long (L) or short (S)], which may affect mRNA stability; 2) the *FokI* polymorphism is not linked to the others and results in a three amino acid shorter VDR molecule, with higher biological activity to activate the rat osteocalcin gene in fibroblasts (248) and to suppress growth of peripheral blood mononuclear cells (60); 3) a *Cdx2* polymorphism was found in the VDR promoter; its expression results in a VDR gene with a defective binding site for the intestine-specific transcription factor *Cdx2* (8), which causes decreased intestinal VDR levels (254), with the concomitant reduction in $1,25(\text{OH})_2\text{D}_3$ induction of calcium transport proteins and calcium absorption (83); and 4) a novel VDR B1 isoform was found in several human cell lines (93). VDR B1 is generated by alternative splicing, thereby rendering a VDR with higher transcriptional activity, due to the 50-amino acid NH_2 -terminal extension of the A/B region with transactivation activity (93).

Importantly, when the functional significance of two unlinked human VDR gene polymorphisms [at a *FokI* restriction site (F/f) in exon II and a microsatellite poly A repeat (L/S)] was examined simultaneously in human fibroblasts spanning >20 genotypes (248), higher transcriptional activity of the F and L biallelic VDR forms was found and statistical significance between genotypes emerged (248).

A more systematic assessment of functional VDR polymorphisms in the population should find clinical application in disease prevention as well as in predicting the response to vitamin D therapy.

Posttranslational Modifications of the VDR

Ligand binding to the VDR promotes serine phosphorylation of the receptor. VDR phosphorylation occurs at several loci and is mediated by various kinases including casein kinase II (at serine 208), PKC (at serine 51), and PKA (117) with diverse effects on transcriptional activity. Clearly, nuclear actions of the VDR could be modulated by other hormonal systems acting at the cell surface to activate protein kinases cascades, as demonstrated by inhibition of osteocalcin gene expression through hyperphosphorylation of the VDR (70). As described earlier, $1,25(\text{OH})_2\text{D}_3$ activation of PKC and other kinases through interaction with cell membrane receptors provides an additional cell-specific mechanism for modulation of the genomic actions of the vitamin D hormone. In fact, $1,25(\text{OH})_2\text{D}_3$ causes a rapid and sustained activation of ERK in bone cells that results in a cell-specific activation or inhibition of VDR transactivation, which is unrelated to VDR content but dependent on the cellular expression of an RXR isoform (176).

A posttranslational VDR modification is induced by substances from uremic plasma ultrafiltrate (192) that react covalently with the VDR at or near the DNA binding domain (193), thus disrupting VDR-RXR binding to DNA. These interactions may partially account for the resistance to vitamin D commonly associated with chronic kidney disease.

Nuclear Levels of Transcriptional VDR Coregulators

As mentioned earlier, the genomic actions of the hormonal form of vitamin D could also be influenced by changes in the nuclear levels or availability of nuclear coregulators of the VDR-RXR complex. Competition between the VDR and transcription factors for other hormonal systems for limiting amounts of common nuclear transcriptional modulators could also affect $1,25(\text{OH})_2\text{D}_3$ -VDR regulation of gene expression, as demonstrated for estrogen squelching of progesterone-mediated transactivation (221).

Physical VDR-protein interactions compromising the DBD of the VDR and, consequently, gene transactivation were demonstrated for nuclear calreticulin in the parathyroid glands of hypocalcemic rats (214) and with Stat1 (246), the transcription factor mediating most biological responses to γ -interferon, in macrophages. The former prevents $1,25(\text{OH})_2\text{D}_3$ transrepression of the PTH gene in vitro, and the latter causes hypercalcemia in sarcoidosis. Mechanistically, increased nuclear calreticulin competes with the VDR for DNA binding. Similarly, γ -interferon-activated Stat1 binds the DBD of the VDR, thus inhibiting the ability of excessive serum $1,25(\text{OH})_2\text{D}_3$ to induce its own catabolism through transactivation of the 24-hydroxylase gene. Extracellular calcium also regulates $1,25(\text{OH})_2\text{D}_3$ -VDR transcriptional activity in keratinocytes through Ca-dependent recruitment of specific sets of nuclear VDR coactivators (24).

The following section on biological actions of vitamin D presents the current understanding of cell-specific molecular events that translate into the most relevant calcitropic and noncalcitropic actions of the vitamin D hormone. These in-

clude 1) VDR interactions with the transcriptional machinery at a particular gene promoter resulting in direct regulation of gene transcription, 2) VDR-independent actions of $1,25(\text{OH})_2\text{D}_3$, and 3) $1,25(\text{OH})_2\text{D}_3$ -VDR actions on critical signaling pathways unrelated to the vitamin D endocrine system.

BIOLOGICAL ACTIONS OF VITAMIN D

Classic Vitamin D-Responsive Tissues

The vitamin D endocrine system is an essential component of the interactions among the kidney, bone, parathyroid gland, and intestine (summarized in Fig. 6) that maintain extracellular calcium levels within narrow limits, a process vital for normal cellular physiology and skeletal integrity. This section discusses the exclusive vs. redundant actions of the $1,25(\text{OH})_2\text{D}_3$ -VDR system compared with those of extracellular calcium in modulating skeletal and mineral homeostasis, based on the evidence obtained from targeted deletion of the genes encoding 1α -hydroxylase, the VDR, or both.

Intestine. Vitamin D is essential to enhance the efficiency of the small intestine to absorb dietary calcium and phosphate. The studies in mice lacking the VDR (150), 1α -hydroxylase, or both (190) corroborated the evidence from patients with vitamin D-dependent rickets type I and II that both $1,25(\text{OH})_2\text{D}_3$ and the VDR are required for optimal intestinal calcium absorption. $1,25(\text{OH})_2\text{D}_3$ induces active cellular calcium uptake and transport mechanisms, as depicted in Fig. 7. Calcium uptake requires the epithelial calcium channel TRPV6 (also known as CaT1 or ECaC2) and, to a lesser extent, TRPV5 (ECaC1). Thereafter, calbindin D transports calcium across the cell, and the plasma membrane Ca^{2+} ATPase, PMCA1b, and the $\text{Na}^+/\text{Ca}^{2+}$ exchanger (NCX1) mediate the final delivery of calcium to the bloodstream (31).

The initial calcium uptake is the rate-limiting step in intestinal calcium absorption and highly dependent on vitamin D (244). The expression of TRPV5 and TRPV6 channels is reduced in the VDR-null mice (31, 244). In contrast, the mRNA levels for both channels are upregulated on calcitriol supplementation in wild-type mice (243). The higher potency

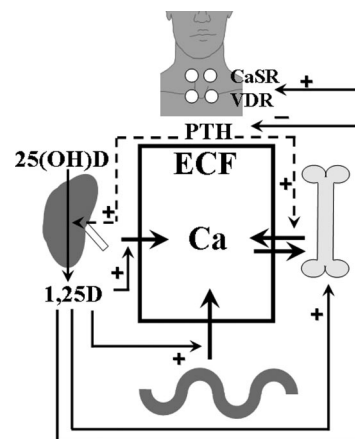

Fig. 6. Role of $1,25(\text{OH})_2\text{D}_3$ in calcium homeostasis. $1,25(\text{OH})_2\text{D}_3$ produced in the kidney induces intestinal calcium absorption, controls bone remodeling, suppresses parathyroid function [parathyroid hormone (PTH) synthesis and cell growth], and renal calcium reabsorption to maintain calcium in the extracellular fluid (ECF) within the narrow limits essential for normal cell physiology and skeletal integrity. CaSR, calcium-sensing receptor.

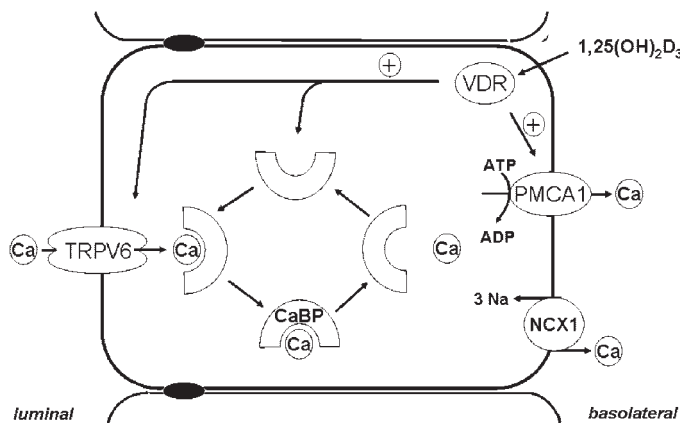

Fig. 7. Regulation of epithelial calcium transport by $1,25(\text{OH})_2\text{D}_3$. Epithelial calcium transport is stimulated by $1,25(\text{OH})_2\text{D}_3$ by induction of 1) the apical calcium channel (TRPV6 or TRPV5) that enhances calcium entry, 2) the cytosolic calcium binding protein (CaBP; calbindin) that facilitates calcium movement across the cell, and 3) the basolateral plasma membrane calcium ATPase (PMCA1) that pumps calcium from the cell. Modified from Ref. 112. NCX1, $\text{Na}^+/\text{Ca}^{2+}$ exchanger.

of calcitriol compared with its analog, $19\text{nor-}1,25(\text{OH})_2\text{D}_2$, in upregulating the expression of these channels could account for the reduced calcemic action of the latter in the intestine (38). Intestinal TRPV5 and TRPV6 expression confers calcium influx with properties identical to those observed in native distal renal cells, including high Ca selectivity and negative feedback regulation to prevent calcium overload during trans-epithelial calcium transport (110).

The calcium-transporting proteins TRPV6, calbindin $\text{D}_{9\text{K}}$, and PMCA1b are increased by high dietary calcium in the duodenum of 1α -hydroxylase-null mice, thus demonstrating a $1,25(\text{OH})_2\text{D}_3$ -independent upregulation (243).

Rapid nongenomic effects of $1,25(\text{OH})_2\text{D}_3$ appear to mediate the increase in both vesicular and paracellular pathways for intestinal calcium absorption. There is controversy, however, on the actual contribution of these nongenomic pathways to intestinal calcium absorption in vivo.

$1,25(\text{OH})_2\text{D}_3$ also increases active phosphate transport through stimulation of the expression of the Na-P_i cotransporter (253) and changes in the composition of the enterocyte plasma membrane (144) that increase fluidity and phosphate uptake. Little is known, however, concerning the molecular mechanisms involved in the extrusion of phosphate across the basolateral membrane into the circulation.

Skeleton. Vitamin D is essential for the development and maintenance of a mineralized skeleton. Vitamin D deficiency results in rickets in young growing animals and osteomalacia in adults. The rescue of the skeletal phenotype of rickets in the VDR-null mice with a high-calcium, high-P, and high-lactose diet ("rescue diet") rendered vitamin D dispensable in skeletal growth, maturation, and remodeling (150). Clinical studies in patients with vitamin D-dependent rickets type II supported these findings. Their abnormalities in bone mineralization were completely resolved by calcium infusion. However, the dispensable role of vitamin D in bone metabolism has been challenged by the comprehensive work by Panda and collaborators (190). In these studies, the phenotype resulting from simultaneous deletion of the genes encoding 1α -hydroxylase and the VDR was compared with those of individual knockout

mouse models that reproduced vitamin D-dependent rickets type I and II, respectively. In addition, in all three mice genotypes, the responses resulting from defective $1,25(\text{OH})_2\text{D}_3$ -VDR were unmasked from those caused indirectly by hypocalcemia or high serum PTH, through dietary manipulations with using the rescue diet or $1,25(\text{OH})_2\text{D}_3$ administration. These studies conclusively demonstrated that, except for cartilage and skeletal mineralization, normalization of serum calcium cannot entirely substitute for defective $1,25(\text{OH})_2\text{D}_3$ -VDR in skeletal homeostasis. Growth plate development requires coordinated calcium and $1,25(\text{OH})_2\text{D}_3$ actions, whereas optimal osteoblastic bone formation and osteoclastic bone resorption demand both $1,25(\text{OH})_2\text{D}_3$ and the VDR. Specifically, all three mouse genotypes presented the characteristic rachitic changes in long bones, such as enlarged and distorted cartilaginous growth plates with a widened hypertrophic zone. The abnormalities were less severe in the VDR-null mice compared with the 1α -hydroxylase knockout mice. $1,25(\text{OH})_2\text{D}_3$ administration to 1α -hydroxylase-null mice could not normalize the growth plate if hypocalcemia was not corrected. Furthermore, elimination of hypocalcemia with the rescue diet did not completely normalize the growth plate. Thus only the combination of high calcium and $1,25(\text{OH})_2\text{D}_3$ could normalize chondrocyte growth, the latter apparently through a novel VDR-independent mechanism.

Furthermore, the $1,25(\text{OH})_2\text{D}_3$ -VDR system was revealed to be critical for the normal coupling of bone remodeling (190). Both osteogenesis and osteoclastogenesis were impaired in the three $1,25(\text{OH})_2\text{D}_3$ -VDR-defective mutants. As expected from the anabolic effects of high levels of PTH that result from hypocalcemia, marked increases in osteoblast number, serum alkaline phosphatase, bone formation, and bone volume were observed in the three $1,25(\text{OH})_2\text{D}_3$ -VDR-defective mutants. However, the defective osteoblastogenesis was unmasked only after correction of hypocalcemia and secondary hyperparathyroidism with the rescue diet. The three "rescued" genotypes elicited reduced osteoblast number, mineral apposition rates, and bone volume compared with wild-type mice in vivo and decreased production of mineralized colonies ex vivo. Taken together, these findings suggest that the $1,25(\text{OH})_2\text{D}_3$ -VDR system may exert an "anabolic" effect necessary to sustain bone-forming activity, which is unmasked only when the defective $1,25(\text{OH})_2\text{D}_3$ -VDR system exists in the presence of normal PTH.

Similarly, an intact $1,25(\text{OH})_2\text{D}_3$ -VDR system is critical for both basal and PTH-induced osteoclastogenesis. In the three mouse genotypes, osteoclast numbers were inappropriately low (i.e., not different from the normocalcemic, vitamin D-replete wild-type controls with normal PTH) considering the high serum PTH. Defective control of receptor activator of NF- κB ligand (RANKL)-receptor activator of NF- κB (RANK) interactions by an altered $1,25(\text{OH})_2\text{D}_3$ -VDR system contributes to abnormal coupling in bone turnover. Figure 8 shows the RANK/RANKL-osteopontin (OPG) interactions between osteoblasts and osteoclasts that integrate bone remodeling (34, 133). Osteoblasts express a surface ligand, RANKL, which can bind either RANK or an osteoblast-derived soluble decoy receptor, OPG. The binding of RANKL to RANK induces a signaling cascade that results in differentiation and maturation of osteoclasts. $1,25(\text{OH})_2\text{D}_3$ as well as PTH and prostaglandins stimulate RANKL expression (137), but $1,25(\text{OH})_2\text{D}_3$ also

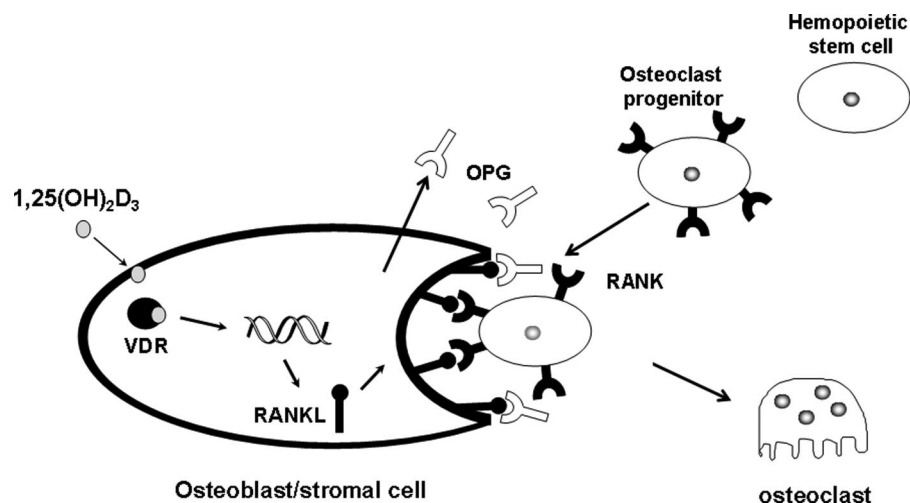

Fig. 8. $1,25(\text{OH})_2\text{D}_3$ regulates osteoclastogenesis by reciprocal regulation of receptor activator of NF- κ B (RANK) ligand (RANKL) and osteoprotegerin (OPG). $1,25(\text{OH})_2\text{D}_3$ -VDR increases the expression of RANKL on the surfaces of the osteoblast. RANKL interaction with its receptor, RANK, promotes maturation of osteoclast progenitor cells to mature osteoclasts, the bone-resorbing cells. $1,25(\text{OH})_2\text{D}_3$ -VDR also represses the expression of OPG, a decoy receptor that binds RANKL and prevents RANK-mediated osteoclastogenesis. Modified from Refs. 95 and 175.

inhibits OPG production (140), with a corresponding increase in osteoclastogenesis and osteoclast activity.

In all three mouse genotypes, osteoclast size was reduced and RANKL expression was low. The rescue diet corrected osteoclast size to that of wild-type mice but could not normalize osteoblastic RANKL content. $1,25(\text{OH})_2\text{D}_3$ administration could not correct either osteoclast size or osteoblastic RANKL levels in the absence of the VDR. Consequently, the $1,25(\text{OH})_2\text{D}_3$ -VDR system appears necessary for maximal PTH-induced osteoclast production. This validates prior studies using an *in vitro* osteoclast-generating model, in which osteoblasts from VDR-null mice stimulated osteoclast production in response to PTH but could not sustain osteoclastogenesis from normal spleen precursors in response to $1,25(\text{OH})_2\text{D}_3$ (231).

Parathyroid glands. The vitamin D endocrine system is a potent modulator of parathyroid function. Whereas vitamin D deficiency results in parathyroid hyperplasia and increased PTH synthesis and secretion, $1,25(\text{OH})_2\text{D}_3$ administration inhibits PTH synthesis and parathyroid cell growth, thus rendering $1,25(\text{OH})_2\text{D}_3$ therapy effective in treating the secondary hyperparathyroidism of chronic kidney disease (75).

In addition to direct transrepression of the PTH gene by the $1,25(\text{OH})_2\text{D}_3$ -VDR complex, $1,25(\text{OH})_2\text{D}_3$ regulates both parathyroid levels of VDR and the response of the parathyroid gland to calcium. $1,25(\text{OH})_2\text{D}_3$ -induced increases in parathyroid VDR result from increases in mRNA levels, possibly secondary to increases in serum calcium (42), as well as through ligand-dependent protection of proteasomal VDR degradation (249). In fact, in rats with kidney failure, a strong direct correlation exists between serum $1,25(\text{OH})_2\text{D}_3$ levels and parathyroid VDR protein content (69). Furthermore, prophylactic $1,25(\text{OH})_2\text{D}_3$ administration prevents the decrease in parathyroid VDR expression that accompanies the progression of kidney disease.

$1,25(\text{OH})_2\text{D}_3$ modulation of the parathyroid gland response to calcium involves direct $1,25\text{D}$ -VDR induction of CaSR gene transcription (41) at the two VDREs in the CaSR promoter (49). Importantly, the rescue diet corrects the high serum PTH levels in the VDR- and 1α -hydroxylase-null mice and in vitamin D-deficient rats (139), suggesting that neither the VDR nor $1,25(\text{OH})_2\text{D}_3$ is essential but are cooperative with calcium in controlling PTH synthesis.

New insights into the mechanisms underlying $1,25(\text{OH})_2\text{D}_3$ suppression of parathyroid hyperplasia emerged after the characterization of the mitogenic signals that trigger the switch of a normally quiescent parathyroid cell to a proliferating one. Increases in parathyroid expression of the growth promoter transforming growth factor- α (TGF- α) and its receptor, the epidermal growth factor receptor (EGFR), mediate the parathyroid growth induced by kidney disease and aggravated by low calcium or high P intake in rats (64, 74). The mechanisms by which $1,25(\text{OH})_2\text{D}_3$ arrests parathyroid cell growth include 1) prevention of the increases in parathyroid expression of the highly mitogenic TGF- α /EGFR growth loop (64, 74); 2) enhancement of parathyroid expression of the cyclin-dependent kinase inhibitors p21 and p27 (64, 74, 237), which are known suppressors of cellular growth; and 3) downregulation of cell membrane and nuclear growth signals from TGF- α -activated EGFR (62).

A critical role of $1,25(\text{OH})_2\text{D}_3$ in the control of parathyroid cell growth emerged from studies in 1α -hydroxylase-null mice. Normalization of serum calcium corrected serum PTH levels but could not suppress parathyroid hyperplasia (190). A novel VDR-independent mechanism appears to mediate the antiproliferative properties of high serum $1,25(\text{OH})_2\text{D}_3$ in the parathyroid glands, because calcium normalization effectively arrests parathyroid growth in VDR knockout mice, which elicit supraphysiological circulating levels of $1,25(\text{OH})_2\text{D}_3$.

Intraparathyroid (percutaneous) injection therapy with the $1,25(\text{OH})_2\text{D}_3$ analog 22-oxacalcitriol regressed parathyroid hyperplasia and induced apoptosis in patients with secondary hyperparathyroidism resistant to intravenous 22-oxacalcitriol (218). It is unclear whether this is attributable to the very high concentration of 22-oxacalcitriol acting on the diminished VDR levels or due to a VDR-independent mechanism.

As expected from $1,25(\text{OH})_2\text{D}_3$ upregulation of parathyroid VDR and CaSR expression, prolonged $1,25(\text{OH})_2\text{D}_3$ deficiency in chronic kidney disease leads to markedly reduced parathyroid VDR and CaSR levels, thereby requiring higher serum calcium or $1,25(\text{OH})_2\text{D}_3$ doses to suppress PTH synthesis or to arrest growth (75).

Kidney. The most important endocrine effect of $1,25(\text{OH})_2\text{D}_3$ in the kidney is a tight control of its own homeostasis through simultaneous suppression of 1α -hydroxylase and stimulation of 24 -hydroxylase and very likely

through its ability to induce megalin expression in the proximal tubule (155).

1,25(OH)₂D₃ involvement in the renal handling of calcium and phosphate continues to be controversial due to the simultaneous effects of 1,25(OH)₂D₃ on serum PTH and on intestinal calcium and phosphate absorption, which affect the filter load of both ions. 1,25(OH)₂D₃ enhances renal calcium reabsorption and calbindin expression and accelerates PTH-dependent calcium transport in the distal tubule (87), the main determinant of the final excretion of calcium into the urine and the site with the highest VDR content. ECaC (or TRPV5) is an important target in 1,25(OH)₂D₃-mediated calcium reabsorption. Several putative VDR binding sites have been located in the human promoter of the renal ECaC. Decreases in circulating levels of 1,25(OH)₂D₃ concentrations resulted in a marked decline in the expression of the channel at the protein and mRNA levels (111).

The effect of 1,25(OH)₂D₃ in improving renal absorption of phosphate in the presence of PTH may not be due to a direct action of the sterol on the kidney.

A renoprotective effect for 1,25(OH)₂D₃ therapy was suggested in the rat model of kidney disease. 1,25(OH)₂D₃ administration attenuates the development of glomerulosclerosis and the progression of albuminuria through PTH-independent antiproliferative actions (213). 1,25(OH)₂D₃-induced decreases in podocyte loss and podocyte hypertrophy (143) may also contribute to the less pronounced albuminuria and glomerulosclerosis.

Nonclassic Vitamin D Actions

Compelling genetic, nutritional, and epidemiological evidence links abnormalities in the vitamin D endocrine system with disorders unrelated to calcium homeostasis, ranging from hypertension and disturbed muscle function to susceptibility to infections, autoimmune diseases, and cancer (114, 266). This section presents the current understanding of the mechanisms underlying the noncalcitropic actions of vitamin D most critical in disease prevention.

Suppression of cell growth. The seminal observations by Abe and collaborators (1) in 1981 that 1,25(OH)₂D₃ inhibits clonal proliferation of a variety of human leukemia cell lines and promotes the differentiation of normal and leukemic myeloid precursors toward more mature, less aggressive phenotypes, rendered 1,25(OH)₂D₃ potentially useful in the treatment of leukemias and other myeloproliferative disorders.

The protective role of vitamin D in cancer was suggested by a strong epidemiological association between prostate, breast, and colon cancer and vitamin D deficiency and was confirmed by nested controlled studies in the case of colorectal and prostate cancer (266). The 1,25(OH)₂D₃-VDR system arrests the cancerous cell cycle at the G1-G0 transition through multiple mechanisms. 1) 1,25(OH)₂D₃ induces gene transcription of the cyclin-dependent kinase inhibitor p21 (154), which appears to be sufficient to arrest growth and promote differentiation in cells of the monocyte-macrophage lineage. 2) 1,25(OH)₂D₃ induces the synthesis and/or stabilization of the cyclin-dependent kinase inhibitor p27. The former involves VDR-Sp1 interactions at the p27 promoter (148), and the latter occurs through VDR-induced reduction of CDK2 activity and Skip2 abundance, the main factors responsible for p27 degra-

tion. In hepatocarcinomas, 1,25(OH)₂D₃ also stabilizes p27 through induction of PTEN, a phosphatase that dephosphorylates p27, thus preventing its proteosomal degradation (160). 3) In tumors in which growth is driven by TGF- α /EGFR overexpression, 1,25(OH)₂D₃ induces the sequestering of ligand-activated EGFR into early endosomes, thus reducing growth signals from ligand-activated EGFR at the cell membrane, and EGFR transactivation of the cyclin D1 gene in the nucleus (62). 1,25(OH)₂D₃ inhibition of the TGF- α /EGFR growth loop could contribute to the efficacy of 1,25(OH)₂D₃ in the treatment of hyperplastic keratinocyte growth in psoriasis, because psoriatic keratinocytes overexpress TGF- α . 4) In the monocytic cell line HL60 (126) and in osteoblasts (100), 1,25(OH)₂D₃ induces C/EBP β expression, a protein recently identified as a potent suppressor of the oncogenic-cyclin D1 signature in human epithelial tumors (146). In contrast, the dominant negative C/EBP β isoform (LIP), which lacks the transactivation domain, potentiates cyclin D1 induction of cellular growth. In EGFR-driven cancers, prevention of increases in LIP partially accounts for the potent antiproliferative properties of EGFR-tyrosine kinase inhibitors (12). Thus in human tumors, the intracellular C/EBP β -to-LIP ratio correlates inversely with proliferating activity (259). A similar induction of C/EBP β expression by 1,25(OH)₂D₃ in cell types other than osteoblasts and monocyte/macrophages should contribute to higher C/EBP-to-LIP ratios and, consequently, to reduced proliferation rates. 1,25(OH)₂D₃ induction of C/EBP β in HL-60 cells promotes the differentiation of these immature myeloid precursors to normal macrophages through C/EBP β interactions with phosphorylated retinoblastoma protein (126). 5) 1,25(OH)₂D₃ reduces the levels of HRPA20, a novel phosphoprotein that enhances growth and survival in the prolactin-dependent rat Nb2T lymphoma, a valuable model of tumor progression in hormone-dependent cancers (130).

At least some of the antiproliferative actions of 1,25(OH)₂D₃ may be autocrine rather than endocrine. 25-Hydroxyvitamin D₃, at concentrations too low to activate the VDR, arrests growth in cells expressing 1 α -hydroxylase (18, 212), whereas targeted deletion of 1 α -hydroxylase in keratinocytes (119) abolishes antiproliferative properties of 25-hydroxyvitamin D₃. An additional consideration for cancer prevention comes from the observation that in prostate cancer cells, the expression of 1 α -hydroxylase decreases with the progression of malignancy, thereby reducing the potency for autocrine 1,25(OH)₂D₃ production to arrest growth (212). The apparently higher antiproliferative efficacy of autocrine vs. exogenously administered 1,25(OH)₂D₃ could result from a differential induction of 1,25(OH)₂D₃ catabolism. Higher 1,25(OH)₂D₃ availability should result from exclusive local induction of 24-hydroxylase compared with the systemic activation of catabolism that follows exogenous 1,25(OH)₂D₃ administration. In fact, in human cancers an inverse association was reported between constitutive expression of 24-hydroxylase in the tumor and the efficacy of vitamin D therapy (65).

Regulation of apoptosis. 1,25(OH)₂D₃-induced apoptosis is an important contributor to the growth-suppressing properties of the sterol in hyperproliferative disorders. In breast cancer cells, 1,25(OH)₂D₃ induces apoptosis through reciprocal modulation in Bcl2 and Bax content (247). It also increases intracellular calcium (216), which activates the calcium-dependent proapoptotic proteases microcalpain and caspase 12, with a

major role for microcalpain (163). $1,25(\text{OH})_2\text{D}_3$ also increases the antitumoral and proapoptotic properties of ionizing radiation in MCF7 breast tumor xenografts in nude mice and TNF- α -induced apoptosis in MCF7 cells through caspase-dependent and -independent mechanisms (229). In contrast to the proapoptotic actions of $1,25(\text{OH})_2\text{D}_3$ in glioma (77), melanoma, and mammary cancer (242), the sterol elicits no proapoptotic effects in normal astrocytes, melanocytes (208), and mammary cells. More importantly, $1,25(\text{OH})_2\text{D}_3$ protects keratinocytes from the apoptosis initiated by UV radiation or chemotherapy (71), and primary melanocytes from that initiated by TNF- α and UV irradiation, the latter through induction of sphingosine 1-phosphate (208).

$1,25(\text{OH})_2\text{D}_3$ induction of calbindin D (28K) appears to mediate the protection from apoptotic cell death, through direct inhibition of caspase 3, in various cell types including 1) presenilin-1 proapoptotic signals in neural cells; 2) PTH/PLC induction of apoptosis in renal cells; 3) cytokine- and free radical-mediated destruction of pancreatic β cells; and 4) TNF- α - and glucocorticoid-induced apoptosis in osteoblastic and osteocytic cells (59).

Importantly, in normal tissues, $1,25(\text{OH})_2\text{D}_3$ proapoptotic properties are critical in controlling hyperplastic growth. In normal mammary tissue, $1,25(\text{OH})_2\text{D}_3$ -VDR control of apoptosis through caspase 3 and Bax induction is required during pregnancy, lactation, and postlactational involution (265). In the absence of hypocalcemia, VDR-null mice exhibit accelerated lobuloalveolar development and premature casein expression during pregnancy, as well as delayed postlactational involution.

Taken together, these findings demonstrate proapoptotic as well as antiapoptotic effects of vitamin D, important in normal tissue development and function, as well as in the induction of growth arrest in cancer and noncancerous hyperproliferative disorders. The association of certain VDR alleles with susceptibility to cancer (241) suggests the involvement of the VDR. In fact, in mammary epithelial tumor cell lines generated in wild-type and VDR-null mice, $1,25(\text{OH})_2\text{D}_3$ inhibits growth and induces apoptosis exclusively in the VDR-containing cells of wild-type mice (242).

In addition, in human colorectal cancer, the transcription factor Snail is expressed and recruited to the native VDR promoter, thereby reducing VDR and, consequently, $1,25(\text{OH})_2\text{D}_3$ -VDR induction of E-cadherin, which influences cell fate during colon cancer progression (189). High levels of Snail causing low VDR content in higher grade colorectal cancers limit the efficacy of $1,25(\text{OH})_2\text{D}_3$ therapy (189). However, VDR content is not the only determinant of the efficacy of $1,25(\text{OH})_2\text{D}_3$ in controlling tumor growth. In prostate cancer, altered levels of expression of the steroid receptor corepressor SMRT or defective nuclear VDR localization, but not reduced VDR levels, is responsible for the resistance to $1,25(\text{OH})_2\text{D}_3$ anti-proliferative properties (132). Interestingly, recent studies showed reversal of the resistance to $1,25(\text{OH})_2\text{D}_3$ therapy caused by decreased VDR and increased NCoR1 content in the breast cancer cell line MDA MB231 using the histone deacetylation inhibitor trichostatin A (13).

Importantly, micromolar concentrations of $1,25(\text{OH})_2\text{D}_3$ arrest growth and induce apoptosis in mammary epithelial tumor cell lines generated from VDR-null mice (242), suggesting the existence of VDR-independent mechanisms.

Modulation of immune responses. The efficacy of the vitamin D endocrine system in controlling infection, autoimmune diseases, and tolerance in transplantation can be attributed to $1,25(\text{OH})_2\text{D}_3$ prodifferentiating effects on monocyte-macrophages, antigen-presenting cells, dendritic cells (DC), and lymphocytes. This section integrates the evidence from in vivo studies in humans and animals lacking either VDR function or vitamin D with that from in vitro findings to assemble a model for the functional regulation of the immune system by $1,25(\text{OH})_2\text{D}_3$.

A causal relationship exists between $1,25(\text{OH})_2\text{D}_3$ -VDR function and innate and adaptive immunity to infections: recurrent infections are commonly associated with vitamin D-deficient rickets (104), and an impaired immune defense mechanism often accompanies the $1,25(\text{OH})_2\text{D}_3$ deficiency of chronic renal failure (10). Subtle changes in VDR function, as the result of the expression of certain VDR alleles, affect the susceptibility or resistance to mycobacterial or viral infection. $1,25(\text{OH})_2\text{D}_3$ also functions as a vaccine adjuvant (68). Mechanistically, $1,25(\text{OH})_2\text{D}_3$ induction of p21 and C/EBP β could mediate the enhancement of monocyte-macrophage immune function. As mentioned earlier, $1,25(\text{OH})_2\text{D}_3$ induction of p21 is sufficient to direct monocyte differentiation toward mature macrophages (154). C/EBP β is a transcription factor critical for macrophage antibacterial, antiviral, and antitumoral activities and for the synthesis of IL-12, the cytokine mediating potent Th1 responses. In fact, severe impairment of all of these macrophage properties occurs in macrophages from C/EBP β -null mice (96). Thus $1,25(\text{OH})_2\text{D}_3$ induction of C/EBP β expression in cells of the monocyte-macrophage lineage (126) could contribute to $1,25(\text{OH})_2\text{D}_3$ -mediated enhancement of monocyte differentiation to macrophage, immune function, host defense against bacterial infection, and tumor cell growth.

Local $1,25(\text{OH})_2\text{D}_3$ production by the disease-activated macrophage could explain the association between vitamin D deficiency and increased susceptibility to mycobacterial infections. Recent studies have provided important insights into cytokine regulation of macrophage $1,25(\text{OH})_2\text{D}_3$ production. γ -Interferon, the cytokine elevated in proportion to the severity of tuberculosis, is a powerful inducer of macrophage 1α -hydroxylase gene expression and, therefore, $1,25(\text{OH})_2\text{D}_3$ production. Interestingly, γ -interferon transactivates macrophage 1α -hydroxylase through a C/EBP β -mediated process (82) similar to that described in cAMP induction of the renal enzyme. In the presence of increased γ -interferon levels, neither is macrophage 1α -hydroxylase subjected to feedback inhibition by $1,25(\text{OH})_2\text{D}_3$ nor can $1,25(\text{OH})_2\text{D}_3$ induce 24 -hydroxylase and, therefore, its own catabolism. Macrophage-produced $1,25(\text{OH})_2\text{D}_3$ not only induces macrophage antibacterial function but synergizes with the Stat1-mediated actions of γ -interferon (246), the most potent macrophage-activating cytokine. Interactions between the $1,25(\text{OH})_2\text{D}_3$ -VDR complex and γ -interferon-activated Stat1 prevent Stat1 deactivation, thus prolonging Stat1 transactivation of γ -interferon-responsive genes, including C/EBP β , which greatly enhance macrophage immune function. The potency of the $1,25(\text{OH})_2\text{D}_3$ -VDR complex in controlling mycobacterial infections in vivo contradicts the in vitro data of $1,25(\text{OH})_2\text{D}_3$ strong suppression of IL-12 and γ -interferon synthesis, as well as Th1 responses. The role of the VDR in the development of Th1 responses is evident from studies in VDR-null mice which showed impaired pro-

duction of the Th1-promoting factor IL-18, decreased Th1 proliferative responses to CD3 and CD28 stimulation in the presence of exogenous IL-12, and decreased expression of Stat4, a Th1 transcription factor (187).

Studies on the function of $1,25(\text{OH})_2\text{D}_3$ as a vaccine adjuvant suggest that local high levels of macrophage-produced $1,25(\text{OH})_2\text{D}_3$ could induce T cell responses, including CD4-Th2 cell-mediated and mucosal antibody responses to cutaneous antigens in vivo, an integral component of the host defense protection mechanism against colonization with infectious agents (104).

In contrast to its stimulatory effects on monocyte-macrophages, $1,25(\text{OH})_2\text{D}_3$ acts as an immunosuppressive agent in lymphocytes (164). Several cytokines involved in T cell functions are direct targets for $1,25(\text{OH})_2\text{D}_3$ actions, including IL-2, which is suppressed via $1,25(\text{OH})_2\text{D}_3$ -VDR impairment of NF-AT complex formation at the distal NF-AT site of the IL-2 promoter (6). $1,25(\text{OH})_2\text{D}_3$ also promotes the development of Th2 cells through direct effects on naive CD4+ cells.

A recently appreciated $1,25(\text{OH})_2\text{D}_3$ action is the maintenance of DC in a state of immaturity. DC are highly specialized antigen-presenting cells that can prime naive T cells in either a tolerogenic (immature) or an immunogenic manner, depending on the nature of the processed antigen and the state of DC maturation. In either monocyte-derived DC or bone marrow-derived DC in vitro, treatment with $1,25(\text{OH})_2\text{D}_3$ results in reduced expression of the costimulatory molecules DC40, DC80, DC86, and IL-12 and increases in IL-10 (195). $1,25(\text{OH})_2\text{D}_3$ also upregulates the ILT3 receptor in DC cells, which associates with tolerance induction and modulation of chemokine production (53). The combination of effects prompts T cells with tolerogenic properties that favor suppressor T cell enhancement.

In relation to $1,25(\text{OH})_2\text{D}_3$ efficacy in the establishment and or maintenance of immunological self-tolerance, seminal studies demonstrate $1,25(\text{OH})_2\text{D}_3$ inhibition of disease induction in experimental autoimmune encephalomyelitis (EAE), thyroiditis, insulin-dependent diabetes mellitus, inflammatory bowel disease (IBD), systemic lupus erythematosus, and both collagen-induced arthritis and Lyme arthritis, as reviewed by Hayes et al. (104) and Adorini et al. (3). Differences exist, however, between EAE and IBD in vitamin D responsiveness. While vitamin D deficiency accelerates the development of EAE, less severe EAE occurs in VDR-null mice (166). This raises some questions as to the relative roles of $1,25(\text{OH})_2\text{D}_3$ and the VDR in regulating immune responsiveness. In contrast, the susceptibility to IBD is markedly enhanced in VDR-null mice (89), raising the interesting possibility that vitamin D regulation of autoimmunity differs between the gastrointestinal tract and the central nervous system. The seasonal variations in the onset and severity of multiple sclerosis provide an important insight into the importance of vitamin D status from sunlight exposure in immune function because serum $25(\text{OH})\text{D}$, but not $1,25(\text{OH})_2\text{D}_3$, varies seasonally (79). The ability of DC cells to synthesize $1,25(\text{OH})_2\text{D}_3$ (88) supports a role for local $1,25(\text{OH})_2\text{D}_3$ production in mounting a tolerogenic response while sensitizing proinflammatory DC to apoptosis (223).

$1,25(\text{OH})_2\text{D}_3$ also inhibits rejection of transplanted tissue. In experimental heart transplantation in rats, $1,25(\text{OH})_2\text{D}_3$ is more efficacious than cyclosporin in prolonging allograft survival, without increasing susceptibility to fungal or viral infec-

tion (122). In renal transplantation, $1,25(\text{OH})_2\text{D}_3$ prolongs the function of the transplanted kidney by decreasing intragraft fibrosis (11). The cross talk between $1,25(\text{OH})_2\text{D}_3$ -VDR and TGF- β /Smad3 interactions appears to mediate this process (256).

The ability of $1,25(\text{OH})_2\text{D}_3$ to reduce rejection in pancreatic islet and liver grafts was attributed to the reduction in the levels of costimulatory molecules in DC cells as well as T suppressor cells. $1,25(\text{OH})_2\text{D}_3$ reduced intragraft levels of IL-2 and IL-12 while increasing IL-4 and IL-10 concentrations, thereby signaling a possible shift to Th2-mediated responses (97).

In summary, the mechanisms underlying $1,25(\text{OH})_2\text{D}_3$ immune actions could be attributed to a paracrine feedback loop that resolves inflammation or influences the differentiation fate of activated CD4 T cells and/or the enhancement of suppressor T cell function, or a combination of these.

Control of differentiation and function in the skin. Vitamin D was used to treat a variety of skin diseases including psoriasis in the 1930s. However, it was not until the mid-1980s that the therapeutic potential of vitamin D in skin diseases reemerged. A dramatic improvement was seen in the psoriatic lesions in a patient receiving oral 1α -hydroxyvitamin D_3 to treat severe osteoporosis (171). As mentioned earlier, $1,25(\text{OH})_2\text{D}_3$ antiproliferative properties in psoriatic keratinocytes overexpressing TGF- α could result from $1,25(\text{OH})_2\text{D}_3$ efficacy in inhibiting mitogenic signals from the TGF- α /EGFR growth loop (62). The immunosuppressive properties of $1,25(\text{OH})_2\text{D}_3$ on Langerhans cells, the antigen-presenting cells of the epidermis, could also mediate the efficacy of the sterol in treating psoriasis, melanoma, and scleroderma.

The $1,25(\text{OH})_2\text{D}_3$ -VDR complex is also essential for normal hair and skin development. The critical role of the VDR, but not $1,25(\text{OH})_2\text{D}_3$, in the hair cycle was conclusively demonstrated by the development of alopecia in patients with hereditary vitamin D-resistant rickets and in VDR-null mice, whereas alopecia is absent in 1α -hydroxylase-null mice or in patients with vitamin-deficient rickets type I. Importantly, unlike other phenotypic features of vitamin D resistance in mice lacking VDR, normalization of serum calcium fails to correct the alopecia, dilated hair follicles, and dermal cysts (150). Further studies on the role of the VDR in the hair cycle allowed the identification of the hairless (Hr) gene as a potent repressor of VDR-mediated transcription. Unlike other VDR corepressors, Hr does not interact with the AF2 domain of the VDR (118).

In normal keratinocytes, locally produced $1,25(\text{OH})_2\text{D}_3$ induces a number of proteins directly involved in differentiation. In addition, autocrine effects of $1,25(\text{OH})_2\text{D}_3$ include increases in CaR and phospholipase C gene expression, which are required for modulation of keratinocyte differentiation by calcium (24). Recent studies in 1α -hydroxylase-null mice indicate that $1,25(\text{OH})_2\text{D}_3$ is mandatory for the maintenance of a steep calcium gradient within the epidermis that affects normal keratinocyte function, the integrity of the permeability barrier, and the recovery when the permeability barrier is disrupted. As mentioned earlier, extracellular calcium induces a differential association of the VDR with two distinct family of coactivator molecules (DRIP205 and SRC3), thus controlling $1,25(\text{OH})_2\text{D}_3$ -VDR transcriptional activity as well as Ca/ $1,25(\text{OH})_2\text{D}_3$ cooperative regulation of keratinocyte differentiation and function.

Control of the renin-angiotensin system. The renin-angiotensin system plays a central role in the regulation of blood pressure, electrolytes, and volume homeostasis. Several epidemiological and clinical studies suggested an association between inadequate sunlight exposure or low serum $1,25(\text{OH})_2\text{D}_3$ with high blood pressure and/or high plasma renin activity (149, 151). $1,25(\text{OH})_2\text{D}_3$ acts as a negative endocrine regulator of the renin-angiotensin system. In VDR-null mice, marked increases in renin expression and plasma angiotensin II production caused hypertension, cardiac hypertrophy, and increased water intake. Corroborative studies in wild-type mice demonstrated that inhibition of $1,25(\text{OH})_2\text{D}_3$ synthesis increased renin expression and that $1,25(\text{OH})_2\text{D}_3$ administration suppressed renin production through a VDR-mediated mechanism unrelated to changes in serum calcium.

Control of insulin secretion. In experimental animals, vitamin D deficiency associates with an earlier and more aggressive onset of diabetes, probably related to abnormalities in immune function, and impaired glucose-mediated insulin secretion that can be reversed by calcitriol repletion (57). $1,25(\text{OH})_2\text{D}_3$, through a VDR-mediated modulation of calbindin expression, appears to control intracellular calcium flux in the islet cells, which, in turn, affects insulin release (58).

In the $1,25(\text{OH})_2\text{D}_3$ deficiency of chronic kidney disease, there is abnormal insulin secretion, a blunted response of the pancreatic β cells to glucose challenge, and insulin resistance (5, 7, 158). $1,25(\text{OH})_2\text{D}_3$ deficiency produces abnormal regulation of insulin secretion independently of alterations in VDR levels in pancreatic β cells. Also, $1,25(\text{OH})_2\text{D}_3$ administration corrects the abnormal insulin secretion independently of changes in serum levels of calcium or PTH (4, 198). The finding of 1α -hydroxylase activity in pancreatic cells (211) raises the possibility of an autocrine control of insulin secretion by $1,25(\text{OH})_2\text{D}_3$.

Control of muscle function. Skeletal muscle weakness and atrophy, with electrophysiological abnormalities in muscle contraction and relaxation, occur in vitamin D deficiency, in $1,25(\text{OH})_2\text{D}_3$ deficiency due to chronic kidney disease, and with the prolonged use of anticonvulsant drugs that decrease serum 25-hydroxyvitamin D levels. Although these defects were originally attributed to low calcium, there is evidence from studies in VDR-null mice of direct $1,25(\text{OH})_2\text{D}_3$ action on skeletal muscle growth and differentiation (28, 80).

In the heart, $1,25(\text{OH})_2\text{D}_3$ controls hypertrophy in cardiac myocytes (251) and the synthesis and release of atrial natriuretic factor (250). In end-stage renal disease, therapy with 25-hydroxyvitamin D or $1,25(\text{OH})_2\text{D}_3$ improves both left ventricular function in patients with cardiomyopathies and skeletal muscle weakness. The mechanisms involved are unclear. In vitro, vitamin D analogs elicit a differential potency to regulate muscle cell metabolism and growth (215), which suggests a therapeutic role in ameliorating the myopathies associated with chronic kidney disease.

Control of the nervous system. $1,25(\text{OH})_2\text{D}_3$ actions in the nervous system include induction of VDR content (VDR is expressed in the brain and on several regions of the central and peripheral nervous system) (43), the conductance velocity of motor neurons, and the synthesis of neurotrophic factors, such as nerve growth factors and neurotrophins, that prevent the loss of injured neurons (47, 50). $1,25(\text{OH})_2\text{D}_3$ also enhances the expression of glial cell line-derived neurotrophic factor, a

potential candidate for treatment of Parkinson's disease (206). In addition to increased nerve growth factor, combined treatment with $1,25(\text{OH})_2\text{D}_3$ and 17β -estradiol in rats elicits neuroprotective effects after focal cortical ischemia induced through the phototrombosis model (157).

$1,25(\text{OH})_2\text{D}_3$ influences critical components of orderly brain development (165). In the embryonic rat brain, the VDR increases steadily from *day 15* to *day 23*, and $1,25(\text{OH})_2\text{D}_3$ induces the expression of nerve growth factor and stimulates neurite outgrowth in embryonic hippocampal explants and primary cultures. Low prenatal vitamin D in utero leads to increased brain size, altered brain shape, enlarged ventricles, and reduced expression of nerve growth factor in the neonatal rat.

The association of vitamin D deficiency and abnormal brain development makes vitamin D an attractive candidate for treatment of schizophrenia, a disorder resulting from gene-environment interactions that disrupt brain development (161). Also, transient prenatal vitamin D deficiency in rats induces hyperlocomotion in adulthood with severe motor abnormalities (45).

CONCLUDING REMARKS

Critical findings in the last five years have improved our understanding of vitamin D bioactivation and actions and the relevance of the vitamin D endocrine system in disease prevention.

In relation to vitamin D bioactivation to $1,25(\text{OH})_2\text{D}_3$, CYP2R1, a nonexclusively hepatic cytochrome *P*-450, was identified as the critical 25-hydroxylase, suggesting that hepatic and extrahepatic 25-hydroxyvitamin D synthesis could contribute to vitamin D status. In the kidney, 25-hydroxyvitamin D uptake by proximal tubular cells was shown to require receptor-mediated endocytosis by megalin, a protein not ubiquitously distributed and induced by $1,25(\text{OH})_2\text{D}_3$, whereas intracellular vitamin D binding proteins mediate the final transport of 25(OH)D to mitochondrial 1α -hydroxylase. Cell-specific differences in the expression of the proteins mediating active substrate uptake and delivery to renal 1α -hydroxylase in kidney disease and to the extrarenal 1α -hydroxylases of DC and numerous other cell types should affect not only serum $1,25(\text{OH})_2\text{D}_3$ levels but local $1,25(\text{OH})_2\text{D}_3$ production and, therefore, $1,25(\text{OH})_2\text{D}_3$ autocrine control of immune responses, cell growth, differentiation, and secretory function.

Of great importance in $1,25(\text{OH})_2\text{D}_3$ -VDR regulation of gene transcription were the findings that the $1,25(\text{OH})_2\text{D}_3$ -VDR complex controls the gene expression of critical nuclear coregulator molecules and splicing by the spliceosome, thus regulating not only the cell competence in inducing or repressing VDR transcriptional activity but also the splicing of transcripts of vitamin D-responsive genes.

Several VDR-dependent and -independent mechanisms were characterized as critical in bone remodeling and renal and intestinal calcium uptake, or parathyroid and chondrocyte growth, respectively. Also, a novel cross talk emerged between extracellular calcium and $1,25(\text{OH})_2\text{D}_3$ -VDR. The $1,25(\text{OH})_2\text{D}_3$ -VDR complex not only controls extracellular calcium levels but the cellular responses to calcium as well, through modulation of the expression of the calcium sensor in the parathyroid glands and in several other tissues, including the kidney. In turn, extracellular calcium modulates the re-

sponse to 1,25(OH)₂D₃-VDR, in a cell-specific manner, through the selective recruitment to the nuclear VDR of co-regulator molecules that affect VDR transactivation potency.

The link between a defective vitamin D endocrine system and hypertension, cancer, and noncarcinogenic hyperproliferative disorders, autoimmune diseases, and susceptibility to infections has been further characterized. The 1,25(OH)₂D₃-VDR complex was found to 1) suppress the renin-angiotensin system; 2) induce C/EBPβ, a potent suppressor of the cyclin D1 oncogene in epithelial carcinomas in humans, and an inducer of macrophage differentiation and immune function; 3) promote and/or prevent apoptosis as required for normal tissue development; 4) inhibit growth signals from activated EGFR in EGFR-driven carcinomas and secondary hyperparathyroidism; and 5) modulate the immunogenic or tolerogenic state of DC, the main determinants of the susceptibility to infections, autoimmune diseases, or the development of tolerance after transplantation.

The strong epidemiological association between vitamin D status [rather than serum 1,25(OH)₂D levels] and susceptibility to infections, autoimmune diseases, and cancer suggests an advantage for local 1,25(OH)₂D₃ production over systemic 1,25(OH)₂D₃ administration in growth arrest, immunomodulation, and cell secretory functions. Future studies in this area should help optimize the use of the vitamin D endocrine system in disease prevention.

ACKNOWLEDGMENTS

The authors thank Cindy Ritter-Brown and Jane Boudreaux for carefully proofreading the manuscript.

GRANTS

This work was supported by National Institutes of Health Grants DK-53774 (to A. J. Brown), AR-45283 (to A. S. Dusso), and DK-62713 (to A. S. Dusso).

REFERENCES

- Abe E, Miyaura C, Sakagami H, Takeda M, Konno K, Yamazaki T, Yoshiki S, and Suda T. Differentiation of mouse myeloid leukemia cells induced by 1α,25-dihydroxyvitamin D₃. *Proc Natl Acad Sci USA* 78: 4990–4994, 1981.
- Adams JS, Chen H, Chun RF, Nguyen L, Wu S, Ren SY, Barsony J, and Gacad MA. Novel regulators of vitamin D action and metabolism: lessons learned at the Los Angeles Zoo. *J Cell Biochem* 88: 308–314, 2003.
- Adorini L, Penna G, Giarratana N, Roncari A, Amuchastegui S, Daniel KC, and Uskokovic M. Dendritic cells as key targets for immunomodulation by vitamin D receptor ligands. *J Steroid Biochem Mol Biol* 89: 437–441, 2004.
- Allegra V, Luisetto G, Mengozzi G, Martimbiano L, and Vasile A. Glucose-induced insulin secretion in uremia: role of 1 α,25(OH)₂-vitamin D₃. *Nephron* 68: 41–47, 1994.
- Allegra V, Mengozzi G, Martimbiano L, and Vasile A. Glucose-induced insulin secretion in uremia: effects of aminophylline infusion and glucose loads. *Kidney Int* 38: 1146–1150, 1990.
- Alroy I, Towers TL, and Freedman LP. Transcriptional repression of the interleukin-2 gene by vitamin D₃: direct inhibition of NFATp/AP-1 complex formation by a nuclear hormone receptor. *Mol Cell Biol* 15: 5789–5799, 1995.
- Alvestrand A, Mujagic M, Wajngot A, and Efendic S. Glucose intolerance in uremic patients: the relative contributions of impaired β-cell function and insulin resistance. *Clin Nephrol* 31: 175–183, 1989.
- Arai H, Miyamoto KI, Yoshida M, Yamamoto H, Taketani Y, Morita K, Kubota M, Yoshida S, Ikeda M, Watabe F, Kanemasa Y, and Takeda E. The polymorphism in the caudal-related homeodomain protein Cdx-2 binding element in the human vitamin D receptor gene. *J Bone Miner Res* 16: 1256–1264, 2001.
- Arbour NC, Prah J, and DeLuca HF. Stabilization of the vitamin D receptor in rat osteosarcoma cells through the action of 1,25-dihydroxyvitamin D₃. *Mol Endocrinol* 7: 1307–1312, 1993.
- Asaka M, Iida H, Izumino K, and Sasayama S. Depressed natural killer cell activity in uremia. Evidence for immunosuppressive factor in uremic sera. *Nephron* 49: 291–295, 1988.
- Aschenbrenner JK, Sollinger HW, Becker BN, and Hullett DA. 1,25-(OH)₂D₃ alters the transforming growth factor beta signaling pathway in renal tissue. *J Surg Res* 100: 171–175, 2001.
- Baldwin BR, Timchenko NA, and Zahnow CA. Epidermal growth factor receptor stimulation activates the RNA binding protein CUG-BP1 and increases expression of C/EBPβ-LIP in mammary epithelial cells. *Mol Cell Biol* 24: 3682–3691, 2004.
- Banwell CM, O'Neill LP, Uskokovic MR, and Campbell MJ. Targeting 1α,25-dihydroxyvitamin D₃ antiproliferative insensitivity in breast cancer cells by co-treatment with histone deacetylation inhibitors. *J Steroid Biochem Mol Biol* 89: 245–249, 2004.
- Baran D, Quail J, Ray R, Leszyk J, and Honeyman T. Identification of the membrane protein that binds 1α,25-dihydroxyvitamin D₃ and is involved in the rapid actions of the hormone (Abstract). *Bone* 23: S176, 1998.
- Baran DT. Nongenomic actions of the steroid hormone 1 α,25-dihydroxyvitamin D₃. *J Cell Biochem* 56: 303–306, 1994.
- Baran DT, Quail JM, Ray R, Leszyk J, and Honeyman T. Annexin II is the membrane receptor that mediates the rapid actions of 1α,25-dihydroxyvitamin D₃. *J Cell Biochem* 78: 34–46, 2000.
- Baran DT, Sorensen AM, Shalhoub V, Owen T, Stein G, and Lian J. The rapid nongenomic actions of 1 α,25-dihydroxyvitamin D₃ modulate the hormone-induced increments in osteocalcin gene transcription in osteoblast-like cells. *J Cell Biochem* 50: 124–129, 1992.
- Barreto AM, Schwartz GG, Woodruff R, and Cramer SD. 25-Hydroxyvitamin D₃, the prohormone of 1,25-dihydroxyvitamin D₃, inhibits the proliferation of primary prostatic epithelial cells. *Cancer Epidemiol Biomarkers Prev* 9: 265–270, 2000.
- Barsony J and McKoy W. Molybdate increases intracellular 3',5'-guanosine cyclic monophosphate and stabilizes vitamin D receptor association with tubulin-containing filaments. *J Biol Chem* 267: 24457–24465, 1992.
- Barsony J, Renyi I, and McKoy W. Subcellular distribution of normal and mutant vitamin D receptors in living cells. Studies with a novel fluorescent ligand. *J Biol Chem* 272: 5774–5782, 1997.
- Beno DWA, Brady LM, Bissonnette M, and Davis BH. Protein kinase C and mitogen-activated protein kinase are required for 1,25-dihydroxyvitamin D₃-stimulated Egr induction. *J Biol Chem* 270: 3642–3647, 1995.
- Berndt T, Craig TA, Bowe AE, Vassiliadis J, Reczek D, Finnegan R, Jan de Beur SM, Schiavi SC, and Kumar R. Secreted frizzled-related protein 4 is potent tumor-derived phosphaturic agent. *J Clin Invest* 112: 785–794, 2003.
- Bikle DD and Gee E. Free, and not total, 1,25-dihydroxyvitamin D regulates 25-hydroxyvitamin D metabolism by keratinocytes. *Endocrinology* 124: 649–654, 1989.
- Bikle DD, Oda Y, and Xie Z. Calcium and 1,25(OH)₂D: interacting drivers of epidermal differentiation. *J Steroid Biochem Mol Biol* 89: 355–360, 2004.
- Birn H, Vorum H, Verroust PJ, Moestrup SK, and Christensen EI. Receptor-associated protein is important for normal processing of megalin in kidney proximal tubules. *J Am Soc Nephrol* 11: 191–202, 2000.
- Bischof MG, Siu-Caldera ML, Weiskopf A, Vouros P, Cross HS, Peterlik M, and Reddy GS. Differentiation-related pathways of 1 α,25-dihydroxycholecalciferol metabolism in human colon adenocarcinoma-derived Caco-2 cells: production of 1 α,25-dihydroxy-3-epi-cholecalciferol. *Exp Cell Res* 241: 194–201, 1998.
- Bland R, Hughes SV, Stewart PM, and Hewison M. Direct regulation of 25-hydroxyvitamin D₃ 1α-hydroxylase by calcium in a human proximal tubule cell line (Abstract). *Bone* 23: S260, 1998.
- Boland R. Role of vitamin D in skeletal muscle function. *Endocr Rev* 7: 434–448, 1986.
- Bouillon R, Okamura WH, and Norman AW. Structure-function relationships in the vitamin D endocrine system. *Endocr Rev* 16: 200–257, 1995.
- Bouillon R, Van Assche FA, Van Baelen H, Heyns W, and De Moor P. Influence of the vitamin D-binding protein on the serum concentration

- of 1,25-dihydroxyvitamin D₃. Significance of the free 1,25-dihydroxyvitamin D₃ concentration. *J Clin Invest* 67: 589–596, 1981.
31. **Bouillon R, Van Cromphaut S, and Carmeliet G.** Intestinal calcium absorption: molecular vitamin D mediated mechanisms. *J Cell Biochem* 88: 332–339, 2003.
 32. **Bourdeau A, Atmani F, Grosse B, and Lieberherr M.** Rapid effects of 1,25-dihydroxyvitamin D₃ and extracellular Ca²⁺ on phospholipid metabolism in dispersed porcine parathyroid cells. *Endocrinology* 127: 2738–2743, 1990.
 33. **Boyan BD, Dean DD, Sylvia VL, and Schwartz Z.** Nongenomic regulation of extracellular matrix events by vitamin D metabolites. *J Cell Biochem* 56: 331–339, 1994.
 34. **Boyle WJ, Simonet WS, and Lacey DL.** Osteoclast differentiation and activation. *Nature* 423: 337–342, 2003.
 35. **Brenza HL, Kimmeljehan C, Jehan F, Shinki T, Wakino S, Anzawa H, Suda T, and DeLuca HF.** Parathyroid hormone activation of the 25-hydroxyvitamin D₃ 1 α -hydroxylase gene promoter. *Proc Natl Acad Sci USA* 95: 1387–1391, 1998.
 36. **Brown AJ, Dusso A, and Slatopolsky E.** Vitamin D. *Am J Physiol Renal Physiol* 277: F157–F175, 1999.
 37. **Brown AJ, Finch J, Grieff M, Ritter C, Kubodera N, Nishii Y, and Slatopolsky E.** The mechanism for the disparate actions of calcitriol and 22-oxacalcitriol in the intestine. *Endocrinology* 133: 1158–1164, 1993.
 38. **Brown AJ, Finch J, and Slatopolsky E.** Differential effects of 19-nor-1,25-dihydroxyvitamin D₂ and 1,25-dihydroxyvitamin D₃ on intestinal calcium and phosphate transport. *J Lab Clin Med* 139: 279–284, 2002.
 39. **Brown AJ, Ritter C, Slatopolsky E, Muralidharan KR, Okamura WH, and Reddy GS.** 1 α ,25-Dihydroxy-3-epi-vitamin D₃, a natural metabolite of 1 α ,25-dihydroxyvitamin D₃, is a potent suppressor of parathyroid hormone secretion. *J Cell Biochem* 73: 106–113, 1999.
 40. **Brown AJ, Ritter CR, Finch JL, Morrissey J, Martin KJ, Murayama E, Nishii Y, and Slatopolsky E.** The noncalcemic analogue of vitamin D, 22-oxacalcitriol, suppresses parathyroid hormone synthesis and secretion. *J Clin Invest* 84: 728–732, 1989.
 41. **Brown AJ, Zhong M, Finch J, Ritter C, McCracken R, Morrissey J, and Slatopolsky E.** Rat calcium-sensing receptor is regulated by vitamin D but not by calcium. *Am J Physiol Renal Fluid Electrolyte Physiol* 270: F454–F460, 1996.
 42. **Brown AJ, Zhong M, Finch J, Ritter C, and Slatopolsky E.** The roles of calcium and 1,25-dihydroxyvitamin D₃ in the regulation of vitamin D receptor expression by rat parathyroid glands. *Endocrinology* 136: 1419–1425, 1995.
 43. **Brown J, Bianco JJ, McGrath JJ, and Eyles DW.** 1,25-Dihydroxyvitamin D₃ induces nerve growth factor, promotes neurite outgrowth and inhibits mitosis in embryonic rat hippocampal neurons. *Neurosci Lett* 343: 139–143, 2003.
 44. **Brumbaugh PF and Haussler MR.** 1 α ,25-Dihydroxycholecalciferol receptors in intestine. I. Association of 1 α ,25-dihydroxycholecalciferol with intestinal mucosa chromatin. *J Biol Chem* 249: 1251–1257, 1974.
 45. **Burne TH, Becker A, Brown J, Eyles DW, Mackay-Sim A, and McGrath JJ.** Transient prenatal vitamin D deficiency is associated with hyperlocomotion in adult rats. *Behav Brain Res* 154: 549–555, 2004.
 46. **Bushinsky DA, Nalbantian-Brandt C, and Favus MJ.** Elevated Ca²⁺ does not inhibit the 1,25(OH)₂D₃ response to phosphorus restriction. *Am J Physiol Renal Fluid Electrolyte Physiol* 256: F285–F289, 1989.
 47. **Cai Q, Tapper DN, Gilmour RF Jr, deTalamoni N, Aloia RC, and Wasserman RH.** Modulation of the excitability of avian peripheral nerves by vitamin D: relation to calbindin-D28k, calcium status and lipid composition. *Cell Calcium* 15: 401–410, 1994.
 48. **Calvo MS and Whiting SJ.** Prevalence of vitamin D insufficiency in Canada and the United States: importance to health status and efficacy of current food fortification and dietary supplement use. *Nutr Rev* 61: 107–113, 2003.
 49. **Canaff L and Hendy GN.** Human calcium-sensing receptor gene. Vitamin D response elements in promoters P1 and P2 confer transcriptional responsiveness to 1,25-dihydroxyvitamin D. *J Biol Chem* 277: 30337–30350, 2002.
 50. **Cantorna MT, Hayes CE, and DeLuca HF.** 1,25-Dihydroxyvitamin D₃ reversibly blocks the progression of relapsing encephalomyelitis, a model of multiple sclerosis. *Proc Natl Acad Sci USA* 93: 7861–7864, 1996.
 51. **Carlberg C.** Ligand-mediated conformational changes of the VDR are required for gene transactivation. *J Steroid Biochem Mol Biol* 89: 227–232, 2004.
 52. **Carling T, Kindmark A, Hellman P, Lundgren E, Ljunghall S, Rastad J, Akerstrom G, and Melhus H.** Vitamin D receptor genotypes in primary hyperparathyroidism. *Nat Med* 1: 1309–1311, 1995.
 53. **Chang CC, Ciubotariu R, Manavalan JS, Yuan J, Colovai AI, Piazza F, Lederman S, Colonna M, Cortesini R, Dalla-Favera R, and Suciu-Foca N.** Tolerization of dendritic cells by T(S) cells: the crucial role of inhibitory receptors ILT3 and ILT4. *Nat Immunol* 3: 237–243, 2002.
 54. **Chen KS and DeLuca HF.** Cloning of the human 1 α ,25-dihydroxyvitamin D-3 24-hydroxylase gene promoter and identification of two vitamin D-responsive elements. *Biochim Biophys Acta* 1263: 1–9, 1995.
 55. **Cheng JB, Levine MA, Bell NH, Mangelsdorf DJ, and Russell DW.** Genetic evidence that the human CYP2R1 enzyme is a key vitamin D 25-hydroxylase. *Proc Natl Acad Sci USA* 101: 7711–7715, 2004.
 56. **Cheng JB, Motola DL, Mangelsdorf DJ, and Russell DW.** De-orphanization of cytochrome P450 2R1: a microsomal vitamin D 25-hydroxylase. *J Biol Chem* 278: 38084–38093, 2003.
 57. **Chertow BS, Sivitz WI, Baranetsky NG, Clark SA, Waite A, and Deluca HF.** Cellular mechanisms of insulin release: the effects of vitamin D deficiency and repletion on rat insulin secretion. *Endocrinology* 113: 1511–1518, 1983.
 58. **Christakos S, Friedlander EJ, Frandsen BR, and Norman AW.** Studies on the mode of action of calciferol. XIII. Development of a radioimmunoassay for vitamin D-dependent chick intestinal calcium-binding protein and tissue distribution. *Endocrinology* 104: 1495–1503, 1979.
 59. **Christakos S and Liu Y.** Biological actions and mechanism of action of calcibindin in the process of apoptosis. *J Steroid Biochem Mol Biol* 89: 401–404, 2004.
 60. **Colin EM, Weel AE, Uitterlinden AG, Buurman CJ, Birkenhager JC, Pols HA, and van Leeuwen JP.** Consequences of vitamin D receptor gene polymorphisms for growth inhibition of cultured human peripheral blood mononuclear cells by 1,25-dihydroxyvitamin D₃. *Clin Endocrinol (Oxf)* 52: 211–216, 2000.
 61. **Cooke NE and Haddad JG.** Vitamin D binding protein (Gc-globulin). *Endocr Rev* 10: 294–307, 1989.
 62. **Cordero JB, Cozzolino M, Lu Y, Vidal M, Slatopolsky E, Stahl PD, Barbieri MA, and Dusso A.** 1,25-Dihydroxyvitamin D downregulates cell membrane growth- and nuclear growth-promoting signals by the epidermal growth factor receptor. *J Biol Chem* 277: 38965–38971, 2002.
 63. **Costa EM and Feldman D.** Homologous up-regulation of the 1,25(OH)₂ vitamin D₃ receptor in rats. *Biochem Biophys Res Commun* 137: 742–747, 1986.
 64. **Cozzolino M, Lu Y, Finch J, Slatopolsky E, and Dusso AS.** p21WAF1 and TGF- α mediate parathyroid growth arrest by vitamin D and high calcium. *Kidney Int* 60: 2109–2117, 2001.
 65. **Cross HS, Kallay E, Farhan H, Weiland T, and Manhardt T.** Regulation of extrarenal vitamin D metabolism as a tool for colon and prostate cancer prevention. *Recent Results Cancer Res* 164: 413–425, 2003.
 66. **Dardenne O, Prudhomme J, Arabian A, Glorieux FH, and St-Arnaud R.** Targeted inactivation of the 25-hydroxyvitamin D₃-1 α -hydroxylase gene (CYP27B1) creates an animal model of pseudovitamin D-deficiency rickets. *Endocrinology* 142: 3135–3141, 2001.
 67. **Darwish HM and DeLuca HF.** Analysis of binding of the 1,25-dihydroxyvitamin D₃ receptor to positive and negative vitamin D response elements. *Arch Biochem Biophys* 334: 223–234, 1996.
 68. **Daynes RA, Enioutina EY, Butler S, Mu HH, McGee ZA, and Araneo BA.** Induction of common mucosal immunity by hormonally immunomodulated peripheral immunization. *Infect Immun* 64: 1100–1109, 1996.
 69. **Denda M, Finch J, Brown AJ, Nishii Y, Kubodera N, and Slatopolsky E.** 1,25-Dihydroxyvitamin D₃ and 22-oxacalcitriol prevent the decrease in vitamin D receptor content in the parathyroid glands of uremic rats. *Kidney Int* 50: 34–39, 1996.
 70. **Desai RK, van Wijnen AJ, Stein JL, Stein GS, and Lian JB.** Control of 1,25-dihydroxyvitamin D₃ receptor-mediated enhancement of osteocalcin gene transcription: effects of perturbing phosphorylation pathways by okadaic acid and staurosporine. *Endocrinology* 136: 5685–5693, 1995.
 71. **Diker-Cohen T, Koren R, Liberman UA, and Ravid A.** Vitamin D protects keratinocytes from apoptosis induced by osmotic shock, oxidative stress, and tumor necrosis factor. *Ann NY Acad Sci* 1010: 350–353, 2003.

72. Dunlop TW, Vaisanen S, Frank C, and Carlberg C. The genes of the coactivator TIF2 and the corepressor SMRT are primary $1\alpha,25(\text{OH})_2\text{D}_3$ targets. *J Steroid Biochem Mol Biol* 89: 257–260, 2004.
73. Dusso AS, Negrea L, Gunawardhana S, Lopez-Hilker S, Finch J, Mori T, Nishii Y, Slatopolsky E, and Brown AJ. On the mechanisms for the selective action of vitamin D analogs. *Endocrinology* 128: 1687–1692, 1991.
74. Dusso AS, Pavlopoulos T, Naumovich L, Lu Y, Finch J, Brown AJ, Morrissey J, and Slatopolsky E. p21WAF1 and transforming growth factor- α mediate dietary phosphate regulation of parathyroid cell growth. *Kidney Int* 59: 855–865, 2001.
75. Dusso AS, Thadhani R, and Slatopolsky E. Vitamin D receptor and analogs. *Semin Nephrol* 24: 10–16, 2004.
76. Eisman JA. Genetics of osteoporosis. *Endocr Rev* 20: 788–804, 1999.
77. Elias J, Marian B, Edling C, Lachmann B, Noe CR, Rolf SH, and Schuster I. Induction of apoptosis by vitamin D metabolites and analogs in a glioma cell line. *Recent Results Cancer Res* 164: 319–332, 2003.
78. Ellgaard L and Frickel EM. Calnexin, calreticulin, and ERp57: teammates in glycoprotein folding. *Cell Biochem Biophys* 39: 223–247, 2003.
79. Embry AF, Snowdon LR, and Vieth R. Vitamin D and seasonal fluctuations of gadolinium-enhancing magnetic resonance imaging lesions in multiple sclerosis. *Ann Neurol* 48: 271–272, 2000.
80. Endo I, Inoue D, Mitsui T, Umaki Y, Akaike M, Yoshizawa T, Kato S, and Matsumoto T. Deletion of vitamin D receptor gene in mice results in abnormal skeletal muscle development with deregulated expression of myoregulatory transcription factors. *Endocrinology* 144: 5138–5144, 2003.
81. Erben RG, Soegiarto DW, Weber K, Zeitz U, Lieberherr M, Gnadecki R, Moller G, Adamski J, and Balling R. Deletion of deoxyribonucleic acid binding domain of the vitamin D receptor abrogates genomic and nongenomic functions of vitamin D. *Mol Endocrinol* 16: 1524–1537, 2002.
82. Esteban L, Vidal M, and Dusso A. 1α -Hydroxylase transactivation by γ -interferon in murine macrophages requires enhanced C/EBP β expression and activation. *J Steroid Biochem Mol Biol* 89: 131–137, 2004.
83. Fang Y, van Meurs JB, Bergink AP, Hofman A, van Duijn CM, van Leeuwen JP, Pols HA, and Uitterlinden AG. Cdx-2 polymorphism in the promoter region of the human vitamin D receptor gene determines susceptibility to fracture in the elderly. *J Bone Miner Res* 18: 1632–1641, 2003.
84. Farach-Carson MC, Abe J, Nishii Y, Khoury R, Wright GC, and Norman AW. 22-Oxalacitriol: dissection of $1,25(\text{OH})_2\text{D}_3$ receptor-mediated and Ca^{2+} entry-stimulating pathways. *Am J Physiol Renal Fluid Electrolyte Physiol* 265: F705–F711, 1993.
85. Farach-Carson MC and Davis PJ. Steroid hormone interactions with target cells: cross talk between membrane and nuclear pathways. *J Pharmacol Exp Ther* 307: 839–845, 2003.
86. Fraser DR and Kodicek E. Unique biosynthesis by kidney of a biological active vitamin D metabolite. *Nature* 228: 764–766, 1970.
87. Friedman PA and Gesek FA. Vitamin D_3 accelerates PTH-dependent calcium transport in distal convoluted tubule cells. *Am J Physiol Renal Fluid Electrolyte Physiol* 265: F300–F308, 1993.
88. Fritsche J, Mondal K, Ehrnsperger A, Andreesen R, and Kreutz M. Regulation of 25-hydroxyvitamin D_3 -1 α -hydroxylase and production of $1\alpha,25$ -dihydroxyvitamin D_3 by human dendritic cells. *Blood* 102: 3314–3316, 2003.
89. Froicu M, Weaver V, Wynn TA, McDowell MA, Welsh JE, and Cantorna MT. A crucial role for the vitamin D receptor in experimental inflammatory bowel diseases. *Mol Endocrinol* 17: 2386–2392, 2003.
90. Fu GK, Lin D, Zhang MYH, Bikle DD, Shackleton CHL, Miller WL, and Portale AA. Cloning of human 25-hydroxyvitamin D-1 α -hydroxylase and mutations causing vitamin D-dependent rickets type I. *Mol Endocrinol* 11: 1961–1970, 1997.
91. Gacad MA and Adams JS. Proteins in the heat shock 70 family specifically bind 25-hydroxyvitamin D-3 and 17- β -estradiol. *J Clin Endocrinol Metab* 83: 1264–1267, 1998.
92. Garabedian M, Holick MF, Deluca HF, and Boyle IT. Control of 25-hydroxycholecalciferol metabolism by parathyroid glands. *Proc Natl Acad Sci USA* 69: 1673–1676, 1972.
93. Gardiner EM, Esteban LM, Fong C, Allison SJ, Flanagan JL, Kouzmenko AP, and Eisman JA. Vitamin D receptor B1 and exon 1d: functional and evolutionary analysis. *J Steroid Biochem Mol Biol* 89: 233–238, 2004.
94. Gomez Alonso C, Naves Diaz ML, Diaz-Corte C, Fernandez Martin JL, and Cannata Andia JB. Vitamin D receptor gene (VDR) polymorphisms: effect on bone mass, bone loss and parathyroid hormone regulation. *Nephrol Dial Transplant* 13: 73–77, 1998.
95. Gonzalez EA. The role of cytokines in skeletal remodelling: possible consequences for renal osteodystrophy. *Nephrol Dial Transplant* 15: 945–950, 2000.
96. Gorgoni B, Maritano D, Marthyn P, Righi M, and Poli V. C/EBP β gene inactivation causes both impaired and enhanced gene expression and inverse regulation of IL-12 p40 and p35 mRNAs in macrophages. *J Immunol* 168: 4055–4062, 2002.
97. Gregori S, Casorati M, Amuchestegui S, Smiroldo S, Davalli AM, and Adorini L. Regulatory T cells induced by $1\alpha,25$ -dihydroxyvitamin D_3 and mycophenolate mofetil treatment mediate transplantation tolerance. *J Immunol* 167: 1945–1953, 2001.
98. Guillemant J and Guillemant S. Early rise in cyclic GMP after $1,25$ -dihydroxycholecalciferol administration in the chick intestinal mucosa. *Biochem Biophys Res Commun* 93: 906–911, 1980.
99. Gupta RP, Hollis BW, Patel SB, Patrick KS, and Bell NH. CYP3A4 is a human microsomal vitamin D 25-hydroxylase. *J Bone Min Res* 19: 680–688, 2004.
100. Gutierrez S, Javed A, Tennant DK, van Rees M, Montecino M, Stein GS, Stein JL, and Lian JB. CCAAT/enhancer-binding proteins (C/EBP) β and δ activate osteocalcin gene transcription and synergize with Runx2 at the C/EBP element to regulate bone-specific expression. *J Biol Chem* 277: 1316–1323, 2002.
101. Haussler MR, Haussler CA, Jurutka PW, Thompson PD, Hsieh JC, Remus LS, Selznick SH, and Whitfield GK. The vitamin D hormone and its nuclear receptor: molecular actions and disease states. *J Endocrinol* 154, Suppl: S57–S73, 1997.
102. Haussler MR, Whitfield GK, Haussler CA, Hsieh JC, Thompson PD, Selznick SH, Dominguez CE, and Jurutka PW. The nuclear vitamin D receptor: biological and molecular regulatory properties revealed. *J Bone Miner Res* 13: 325–349, 1998.
103. Hayashi S, Usui E, and Okuda K. Sex-related differences in vitamin D_3 25-hydroxylase of rat liver microsomes. *J Biochem* 103: 863–866, 1988.
104. Hayes CE, Nashold FE, Spach KM, and Pedersen LB. The immunological functions of the vitamin D endocrine system. *Cell Mol Biol (Noisy-le-grand)* 49: 277–300, 2003.
105. Hedlund TE, Moffatt KA, and Miller GJ. Stable expression of the nuclear vitamin D receptor in the human prostatic carcinoma cell line JCA-1: evidence that the antiproliferative effects of $1\alpha, 25$ -dihydroxyvitamin D_3 are mediated exclusively through the genomic signaling pathway. *Endocrinology* 137: 1554–1561, 1996.
106. Henry HL. Regulation of the hydroxylation of 25-hydroxyvitamin D_3 in vivo and in primary cultures of chick kidney cells. *J Biol Chem* 254: 2722–2729, 1979.
107. Henry HL and Norman AW. Vitamin D: metabolism and biological actions. *Annu Rev Nutr* 4: 493–520, 1984.
108. Hewison M, Rut AR, Kristjansson K, Walker RE, Dillon MJ, Hughes MR, and O’Riordan JL. Tissue resistance to $1,25$ -dihydroxyvitamin D without a mutation of the vitamin D receptor gene. *Clin Endocrinol (Oxf)* 39: 663–670, 1993.
109. Hewison M, Zehnder D, Chakraverty R, and Adams JS. Vitamin D and barrier function: a novel role for extra-renal 1α -hydroxylase. *Mol Cell Endocrinol* 215: 31–38, 2004.
110. Hoenderop JG, Chon H, Gkika D, Bluysen HA, Holstege FC, St-Arnaud R, Braam B, and Bindels RJ. Regulation of gene expression by dietary Ca^{2+} in kidneys of 25-hydroxyvitamin D_3 -1 α -hydroxylase knockout mice. *Kidney Int* 65: 531–539, 2004.
111. Hoenderop JG, Muller D, Van Der Kemp AW, Hartog A, Suzuki M, Ishibashi K, Imai M, Sweep F, Willems PH, Van Os CH, and Bindels RJ. Calcitriol controls the epithelial calcium channel in kidney. *J Am Soc Nephrol* 12: 1342–1349, 2001.
112. Hoenderop JG, Willems PH, and Bindels RJ. Toward a comprehensive molecular model of active calcium reabsorption. *Am J Physiol Renal Physiol* 278: F352–F360, 2000.
113. Holick MF. The cutaneous photosynthesis of previtamin D_3 : a unique photoendocrine system. *J Invest Dermatol* 77: 51–58, 1981.
114. Holick MF. Vitamin D: importance in the prevention of cancers, type 1 diabetes, heart disease, and osteoporosis. *Am J Clin Nutr* 79: 362–371, 2004.

115. **Holick MF, Frommer JE, McNeill SC, Richtand NM, Henley JW, and Potts JT Jr.** Photometabolism of 7-dehydrocholesterol to previtamin D₃ in skin. *Biochem Biophys Res Commun* 76: 107–114, 1977.
116. **Hruska KA, Bar-Shavit Z, Malone JD, and Teitelbaum S.** Ca²⁺ priming during vitamin D-induced monocytic differentiation of a human leukemia cell line. *J Biol Chem* 263: 16039–16044, 1988.
117. **Hsieh JC, Jurutka PW, Galligan MA, Terpening CM, Haussler CA, Samuels DS, Shimizu Y, Shimizu N, and Haussler MR.** Human vitamin D receptor is selectively phosphorylated by protein kinase C on serine 51, a residue crucial to its trans-activation function. *Proc Natl Acad Sci USA* 88: 9315–9319, 1991.
118. **Hsieh JC, Sisk JM, Jurutka PW, Haussler CA, Slater SA, Haussler MR, and Thompson CC.** Physical and functional interaction between the vitamin D receptor and hairless corepressor, two proteins required for hair cycling. *J Biol Chem* 278: 38665–38674, 2003.
119. **Huang DC, Papavasiliou V, Rhim JS, Horst RL, and Kremer R.** Targeted disruption of the 25-hydroxyvitamin D₃ 1 α -hydroxylase gene in ras-transformed keratinocytes demonstrates that locally produced 1 α ,25-dihydroxyvitamin D₃ suppresses growth and induces differentiation in an autocrine fashion. *Mol Cancer Res* 1: 56–67, 2002.
120. **Hughes MR, Brumbaugh PF, Hussler MR, Wergedal JE, and Baylink DJ.** Regulation of serum 1 α ,25-dihydroxyvitamin D₃ by calcium and phosphate in the rat. *Science* 190: 578–580, 1975.
121. **Huhtakangas JA, Olivera CJ, Bishop JE, Zanella LP, and Norman AW.** The vitamin D receptor is present in caveolae-enriched plasma membranes and binds 1 α ,25(OH)₂-vitamin D₃ in vivo and in vitro. *Mol Endocrinol* 18: 2660–2671, 2004.
122. **Hullett DA, Cantorna MT, Redaelli C, Humpal-Winter J, Hayes CE, Sollinger HW, and Deluca HF.** Prolongation of allograft survival by 1,25-dihydroxyvitamin D₃. *Transplantation* 66: 824–828, 1998.
123. **Ishizuka S, Kurihara N, Hakeda S, Maeda N, Ikeda K, Kumegawa M, and Norman AW.** 1 α ,25-Dihydroxyvitamin D₃[1 α ,25-(OH)₂D₃]-26,23-lactone inhibits 1,25-(OH)₂D₃-mediated fusion of mouse bone marrow mononuclear cells. *Endocrinology* 123: 781–786, 1988.
124. **Ishizuka S and Norman AW.** Metabolic pathways from 1 α ,25-dihydroxyvitamin D₃ to 1 α ,25-dihydroxyvitamin D₃-26,23-lactone. Stereo-retained and stereo-selective lactonization. *J Biol Chem* 262: 7165–7170, 1987.
125. **Jaaskelainen T, Ryhanen S, Mahonen A, DeLuca HF, and Maenpaa PH.** Mechanism of action of superactive vitamin D analogs through regulated receptor degradation. *J Cell Biochem* 76: 548–558, 2000.
126. **Ji Y and Studzinski GP.** Retinoblastoma protein and CCAAT/enhancer-binding protein beta are required for 1,25-dihydroxyvitamin D₃-induced monocytic differentiation of HL60 cells. *Cancer Res* 64: 370–377, 2004.
127. **Jurutka PW, Terpening CM, and Haussler MR.** The 1,25-dihydroxyvitamin D₃ receptor is phosphorylated in response to 1,25-dihydroxyvitamin D₃ and 22-oxacalcitriol in rat osteoblasts, and by casein kinase II, in vitro. *Biochemistry* 32: 8184–8192, 1993.
128. **Jurutka PW, Whitfield GK, Hsieh JC, Thompson PD, Haussler CA, and Haussler MR.** Molecular nature of the vitamin D receptor and its role in regulation of gene expression. *Rev Endocr Metab Disord* 2: 203–216, 2001.
129. **Kamimura S, Gallieni M, Zhong M, Beron W, Slatopolsky E, and Dusso A.** Microtubules mediate cellular 25-hydroxyvitamin D₃ trafficking and the genomic response to 1,25-dihydroxyvitamin D₃ in normal human monocytes. *J Biol Chem* 270: 22160–22166, 1995.
130. **Karp CM, Pan H, Zhang M, Buckley DJ, Schuler LA, and Buckley AR.** Identification of HRPAP20: a novel phosphoprotein that enhances growth and survival in hormone-responsive tumor cells. *Cancer Res* 64: 1016–1025, 2004.
131. **Kato S, Fujiki R, and Kitagawa H.** Vitamin D receptor (VDR) promoter targeting through a novel chromatin remodeling complex. *J Steroid Biochem Mol Biol* 89: 173–178, 2004.
132. **Khanim FL, Gommersall LM, Wood VH, Smith KL, Montalvo L, O'Neill LP, Xu Y, Peehl DM, Stewart PM, Turner BM, and Campbell MJ.** Altered SMRT levels disrupt vitamin D₃ receptor signalling in prostate cancer cells. *Oncogene* 23: 6712–6725, 2004.
133. **Khosla S.** Minireview: the OPG/RANKL/RANK system. *Endocrinology* 142: 5050–5055, 2001.
134. **Khoury R, Ridall AL, Norman AW, and Farach-Carson MC.** Target gene activation by 1,25-dihydroxyvitamin D₃ in osteosarcoma cells is independent of calcium influx. *Endocrinology* 135: 2446–2453, 1994.
135. **Khoury RS, Weber J, and Farach-Carson MC.** Vitamin D metabolites modulate osteoblast activity by Ca²⁺ influx-independent genomic and Ca²⁺ influx-dependent nongenomic pathways. *J Nutr* 125: 1699S–1703S, 1995.
136. **Kitanaka S, Takeyama K, Murayama A, Sato T, Okumura K, Nogami M, Hasegawa Y, Niimi H, Yanagisawa J, Tanaka T, and Kato S.** Inactivating mutations in the 25-hydroxyvitamin D₃ 1 α -hydroxylase gene in patients with pseudovitamin D-deficiency rickets. *N Engl J Med* 338: 653–661, 1998.
137. **Kitazawa S, Kajimoto K, Kondo T, and Kitazawa R.** Vitamin D₃ supports osteoclastogenesis via functional vitamin D response element of human RANKL gene promoter. *J Cell Biochem* 89: 771–777, 2003.
138. **Koike N, Hayakawa N, Kumaki K, and Stumpf WE.** In vivo dose-related receptor binding of the vitamin D analogue [³H]-1,25-dihydroxy-22-oxavitamin D₃ (OCT) in rat parathyroid, kidney distal and proximal tubules, duodenum, and skin, studied by quantitative receptor autoradiography. *J Histochem Cytochem* 46: 1351–1358, 1998.
139. **Kollenkirchen U, Fox J, and Walters MR.** Normocalcemia without hyperparathyroidism in vitamin D-deficient rats. *J Bone Miner Res* 6: 273–278, 1991.
140. **Kondo T, Kitazawa R, Maeda S, and Kitazawa S.** 1,25 Dihydroxyvitamin D₃ rapidly regulates the mouse osteoprotegerin gene through dual pathways. *J Bone Miner Res* 19: 1411–1419, 2004.
141. **Kontula K, Valimaki S, Kainulainen K, Viitanen AM, and Keski-Oja J.** Vitamin D receptor polymorphism and treatment of psoriasis with calcipotriol. *Br J Dermatol* 136: 977–978, 1997.
142. **Koshiyama H, Sone T, and Nakao K.** Vitamin-D-receptor-gene polymorphism and bone loss. *Lancet* 345: 990–991, 1995.
143. **Kuhlmann A, Haas CS, Gross ML, Reulbach U, Holzinger M, Schwarz U, Ritz E, and Amann K.** 1,25-Dihydroxyvitamin D₃ decreases podocyte loss and podocyte hypertrophy in the subtotaly nephrectomized rat. *Am J Physiol Renal Physiol* 286: F526–F533, 2004.
144. **Kurnik BR and Hruska KA.** Mechanism of stimulation of renal phosphate transport by 1,25-dihydroxycholecalciferol. *Biochim Biophys Acta* 817: 42–50, 1985.
145. **Labuda M, Morgan K, and Glorieux FH.** Mapping autosomal recessive vitamin D dependency type 1 to chromosome 12q14 by linkage analysis. *Am J Hum Genet* 47: 28–36, 1990.
146. **Lamb J, Ramaswamy S, Ford HL, Contreras B, Martinez RV, Kittrell FS, Zahnow CA, Patterson N, Golub TR, and Ewen ME.** A mechanism of cyclin D1 action encoded in the patterns of gene expression in human cancer. *Cell* 114: 323–334, 2003.
147. **Leong GM, Subramaniam N, Issa LL, Barry JB, Kino T, Driggers PH, Hayman MJ, Eisman JA, and Gardiner EM.** Ski-interacting protein, a bifunctional nuclear receptor coregulator that interacts with N-CoR/SMRT and p300. *Biochem Biophys Res Commun* 315: 1070–1076, 2004.
148. **Li P, Li C, Zhao X, Zhang X, Nicosia SV, and Bai W.** p27(Kip1) stabilization and G₁ arrest by 1,25-dihydroxyvitamin D₃ in ovarian cancer cells mediated through down-regulation of cyclin E/cyclin-dependent kinase 2 and Skp1-Cullin-F-box protein/Skp2 ubiquitin ligase. *J Biol Chem* 279: 25260–25267, 2004.
149. **Li YC.** Vitamin D regulation of the renin-angiotensin system. *J Cell Biochem* 88: 327–331, 2003.
150. **Li YC, Amling M, Pirro AE, Priemel M, Meuse J, Baron R, Delling G, and Demay MB.** Normalization of mineral ion homeostasis by dietary means prevents hyperparathyroidism, rickets, and osteomalacia, but not alopecia in vitamin D receptor-ablated mice. *Endocrinology* 139: 4391–4396, 1998.
151. **Li YC, Kong J, Wei M, Chen ZF, Liu SQ, and Cao LP.** 1,25-Dihydroxyvitamin D₃ is a negative endocrine regulator of the renin-angiotensin system. *J Clin Invest* 110: 229–238, 2002.
152. **Lieberherr M.** Effects of vitamin D₃ metabolites on cytosolic free calcium in confluent mouse osteoblasts. *J Biol Chem* 262: 13168–13173, 1987.
153. **Lieberherr M, Grosse B, Duchambon P, and Druke T.** A functional cell surface type receptor is required for the early action of 1,25-dihydroxyvitamin D₃ on the phosphoinositide metabolism in rat enterocytes. *J Biol Chem* 264: 20403–20406, 1989.
154. **Liu M, Lee MH, Cohen M, Bommakanti M, and Freedman LP.** Transcriptional activation of the Cdk inhibitor p21 by vitamin D₃ leads to the induced differentiation of the myelomonocytic cell line U937. *Genes Dev* 10: 142–153, 1996.
155. **Liu W, Yu WR, Carling T, Juhlin C, Rastad J, Ridefelt P, Akerstrom G, and Hellman P.** Regulation of gp330/megalin expression by vitamins A and D. *Eur J Clin Invest* 28: 100–107, 1998.

157. **Losem-Heinrichs E, Gorg B, Schleicher A, Redecker C, Witte OW, Zilles K, and Bidmon HJ.** A combined treatment with $1\alpha,25$ -dihydroxyvitamin D_3 and 17β -estradiol reduces the expression of heat shock protein-32 (HSP-32) following cerebral cortical ischemia. *J Steroid Biochem Mol Biol* 89: 371–374, 2004.
158. **Lowrie EG, Soeldner JS, Hampers CL, and Merrill JP.** Glucose metabolism and insulin secretion in uremic, prediabetic, and normal subjects. *J Lab Clin Med* 76: 603–615, 1970.
159. **Lucas PA, Roulet C, Duchambon P, Lacour B, and Drueke T.** Rapid stimulation of calcium uptake by isolated rat enterocytes by $1,25(OH)_2D_3$. *Pflügers Arch* 413: 407–413, 1989.
160. **Luo W, Chen J, Zhang X, and Wang W.** Regulatory mechanism of EB1089 for hepatocarcinoma cell proliferation. *Wei Sheng Yan Jiu* 33: 140–143, 2004.
161. **Mackay-Sim A, Feron F, Eyles D, Burne T, and McGrath J.** Schizophrenia, vitamin D, and brain development. *Int Rev Neurobiol* 59: 351–380, 2004.
162. **Masuyama H and MacDonald PN.** Proteasome-mediated degradation of the vitamin D receptor (VDR) and a putative role for SUG1 interaction with the AF-2 domain of VDR. *J Cell Biochem* 71: 429–440, 1998.
163. **Mathiasen IS, Sergeev IN, Bastholm L, Elling F, Norman AW, and Jaattela M.** Calcium and calpain as key mediators of apoptosis-like death induced by vitamin D compounds in breast cancer cells. *J Biol Chem* 277: 30738–30745, 2002.
164. **Mathieu C and Adorini L.** The coming of age of $1,25$ -dihydroxyvitamin D_3 analogs as immunomodulatory agents. *Trends Mol Med* 8: 174–179, 2002.
165. **McGrath JJ, Feron FP, Burne TH, Mackay-Sim A, and Eyles DW.** Vitamin D_3 implications for brain development. *J Steroid Biochem Mol Biol* 89–90: 557–560, 2004.
166. **Meehan TF and DeLuca HF.** The vitamin D receptor is necessary for $1\alpha,25$ -dihydroxyvitamin D_3 to suppress experimental autoimmune encephalomyelitis in mice. *Arch Biochem Biophys* 408: 200–204, 2002.
167. **Mellon WS and DeLuca HF.** An equilibrium and kinetic study of $1,25$ -dihydroxyvitamin D_3 binding to chicken intestinal cytosol employing high specific activity $1,25$ -dehydroxy [3H -26, 27] vitamin D_3 . *Arch Biochem Biophys* 197: 90–95, 1979.
168. **Mizwicki MT, Bishop JE, Olivera CJ, Huhtakangas JA, and Norman AW.** Evidence that annexin II in not a putative membrane receptor for $1\alpha,25(OH)_2$ -vitamin D_3 . *J Cell Biochem* 91: 852–863, 2004.
169. **Monkawa T, Yoshida T, Wakino S, Shinki T, Anazawa H, Deluca HF, Suda T, Hayashi M, and Saruta T.** Molecular cloning of cDNA and genomic DNA for human 25 -hydroxyvitamin D_3 1α -hydroxylase. *Biochem Biophys Res Commun* 239: 527–533, 1997.
170. **Morelli S, de Boland AR, and Boland RL.** Generation of inositol phosphates, diacylglycerol and calcium fluxes in myoblasts treated with $1,25$ -dihydroxyvitamin D_3 . *Biochem J* 289: 675–679, 1993.
171. **Morimoto S and Kumahara Y.** A patient with psoriasis cured by 1α -hydroxyvitamin D_3 . *Med J Osaka Univ* 35: 51–54, 1985.
172. **Morrison NA, Qi JC, Tokita A, Kelly PJ, Crofts L, Nguyen TV, Sambrook PN, and Eisman JA.** Prediction of bone density from vitamin D receptor alleles. *Nature* 367: 284–287, 1994.
173. **Murayama A, Takeyama K, Kitanaka S, Koderia Y, Hosoya T, and Kato S.** The promoter of the human 25 -hydroxyvitamin D_3 1α -hydroxylase gene confers positive and negative responsiveness to Pth, calcitonin, and $1\alpha,25(OH)_2D_3$. *Biochem Biophys Res Commun* 249: 11–16, 1998.
174. **Nakagawa K, Sowa Y, Kurobe M, Ozono K, Siu-Caldera ML, Reddy GS, Uskokovic MR, and Okano T.** Differential activities of $1\alpha,25$ -dihydroxy- 16 -ene-vitamin D_3 analogs and their 3-epimers on human promyelocytic leukemia (HL-60) cell differentiation and apoptosis. *Steroids* 66: 327–337, 2001.
175. **Nakagawa N, Kinoshita M, Yamaguchi K, Shima N, Yasuda H, Yano K, Morinaga T, and Higashio K.** RANK is the essential signaling receptor for osteoclast differentiation factor in osteoclastogenesis. *Biochem Biophys Res Commun* 253: 395–400, 1998.
176. **Narayanan R, Sepulveda VA, Falzon M, and Weigel NL.** The functional consequences of cross talk between the vitamin D receptor and ERK signaling pathways are cell specific. *J Biol Chem* 279: 47298–47310, 2004.
177. **Nemere I, Dormanen MC, Hammond MW, Okamura WH, and Norman AW.** Identification of a specific binding protein for $1\alpha,25$ -dihydroxyvitamin D_3 in basal-lateral membranes of chick intestinal epithelium and relationship to transcalcaltachia. *J Biol Chem* 269: 23750–23756, 1994.
178. **Nemere I, Farach-Carson MC, Rohe B, Sterling TM, Norman AW, Boyan BD, and Safford SE.** Ribozyme knockdown functionally links a $1,25(OH)_2D_3$ membrane binding protein ($1,25D_3$ -MARRS) and phosphate uptake in intestinal cells. *Proc Natl Acad Sci USA* 101: 7392–7397, 2004.
179. **Nemere I, Schwartz Z, Pedrozo H, Sylvia VL, Dean DD, and Boyan BD.** Identification of a membrane receptor for $1,25$ -dihydroxyvitamin D_3 which mediates the rapid activation of protein kinase C. *J Bone Miner Res* 13: 1353–1359, 1998.
180. **Nemere I, Yoshimoto Y, and Norman AW.** Calcium transport in perfused duodena from normal chicks: enhancement within fourteen minutes of exposure to $1,25$ -dihydroxyvitamin D_3 . *Endocrinology* 115: 1476–1483, 1984.
181. **Norman AW, Bouillon R, Farach-Carson MC, Bishop JE, Zhou LX, Nemere I, Zhao J, Muralidharan KR, and Okamura WH.** Demonstration that $1\beta,25$ -dihydroxyvitamin D_3 is an antagonist of the non-genomic but not genomic biological responses and biological profile of the three A-ring diastereomers of $1\alpha,25$ -dihydroxyvitamin D_3 . *J Biol Chem* 268: 20022–20030, 1993.
182. **Norman AW, Song X, Zanella L, Bula C, and Okamura WH.** Rapid and genomic biological responses are mediated by different shapes of the agonist steroid hormone, $1\alpha,25(OH)_2$ vitamin D_3 . *Steroids* 64: 120–128, 1999.
183. **Nykjaer A, Dragun D, Walther D, Vorum H, Jacobsen C, Herz J, Melsen F, Christensen E, and Willnow T.** An endocytic pathway essential for renal uptake and activation of the steroid $25(OH)$ vitamin D_3 . *Cell* 96: 507–515, 1999.
184. **Nykjaer A, Fyfe JC, Kozyraki R, Leheste JR, Jacobsen C, Nielsen MS, Verroust PJ, Aminoff M, de la Chapelle A, Moestrup SK, Ray R, Gliemann J, Willnow TE, and Christensen EI.** Cubilin dysfunction causes abnormal metabolism of the steroid hormone $25(OH)$ vitamin D_3 . *Proc Natl Acad Sci USA* 98: 13895–13900, 2001.
185. **Ohyama Y, Ozono K, Uchida M, Shinki T, Kato S, Suda T, Yamamoto O, Noshiro M, and Kato Y.** Identification of a vitamin D-responsive element in the 5'-flanking region of the rat 25 -hydroxyvitamin D_3 24 -hydroxylase gene. *J Biol Chem* 269: 10545–10550, 1994.
186. **Okano T, Yasumura M, Mizuno K, and Kobayashi T.** Photochemical conversion of 7-dehydrocholesterol into vitamin D_3 in rat skins. *J Nutr Sci Vitaminol* 23: 165–168, 1977.
187. **O'Kelly J, Hisatake J, Hisatake Y, Bishop J, Norman A, and Koeffler HP.** Normal myelopoiesis but abnormal T lymphocyte responses in vitamin D receptor knockout mice. *J Clin Invest* 109: 1091–1099, 2002.
188. **Omdahl JL, Gray RW, Boyle IT, Knutson J, and DeLuca HF.** Regulation of metabolism of 25 -hydroxycholecalciferol by kidney tissue in vitro by dietary calcium. *Nat New Biol* 237: 63–64, 1972.
189. **Palmer HG, Larrriba MJ, Garcia JM, Ordenez-Moran P, Pena C, Peiro S, Puig I, Rodriguez R, De La Fuente R, Bernad A, Pollan M, Bonilla F, Gamallo C, De Herreros AG, and Munoz A.** The transcription factor SNAIL represses vitamin D receptor expression and responsiveness in human colon cancer. *Nat Med* 10: 917–919, 2004.
190. **Panda DK, Miao D, Bolivar I, Li J, Huo R, Hendy GN, and Goltzman D.** Inactivation of the 25 -hydroxyvitamin D 1α -hydroxylase and vitamin D receptor demonstrates independent and interdependent effects of calcium and vitamin D on skeletal and mineral homeostasis. *J Biol Chem* 279: 16754–16766, 2004.
191. **Panda DK, Miao D, Tremblay ML, Sirois J, Farookhi R, Hendy GN, and Goltzman D.** Targeted ablation of the 25 -hydroxyvitamin D 1α -hydroxylase: evidence for skeletal, reproductive and immune dysfunction. *Proc Natl Acad Sci USA* 98: 7498–7503, 2001.
192. **Patel SR, Ke HQ, Vanholder R, Koenig RJ, and Hsu CH.** Inhibition of calcitriol receptor binding to vitamin D response elements by uremic toxins. *J Clin Invest* 96: 50–59, 1995.
193. **Patel SR, Koenig RJ, and Hsu CH.** Effect of Schiff base formation on the function of the calcitriol receptor. *Kidney Int* 50: 1539–1545, 1996.
194. **Peleg S, Liu YY, Reddy S, Horst RL, White MC, and Posner GH.** A 20-epi side chain restores growth-regulatory and transcriptional activities of an A ring-modified hybrid analog of $1\alpha,25$ -dihydroxyvitamin D_3 without increasing its affinity to the vitamin D receptor. *J Cell Biochem* 63: 149–161, 1996.
195. **Penna G and Adorini L.** $1\alpha,25$ -Dihydroxyvitamin D_3 inhibits differentiation, maturation, activation, and survival of dendritic cells leading to impaired alloreactive T cell activation. *J Immunol* 164: 2405–2411, 2000.

196. **Petersen HH, Hilpert J, Militz D, Zandler V, Jacobsen C, Roebroek AJ, and Willnow TE.** Functional interaction of megalin with the megalin binding protein (MegBP), a novel tetratricopeptide repeat-containing adaptor molecule. *J Cell Sci* 116: 453–461, 2003.
197. **Picard F, Gehin M, Annicotte J, Rocchi S, Champy MF, O'Malley BW, Chambon P, and Auwerx J.** SRC-1 and TIF2 control energy balance between white and brown adipose tissues. *Cell* 111: 931–941, 2002.
198. **Quesada JM, Martin-Malo A, Santiago J, Hervas F, Martinez ME, Castillo D, Barrio V, and Aljama P.** Effect of calcitriol on insulin secretion in uraemia. *Nephrol Dial Transplant* 5: 1013–1017, 1990.
199. **Rachez C and Freedman LP.** Mechanisms of gene regulation by vitamin D₃ receptor: a network of coactivator interactions. *Gene* 246: 9–21, 2000.
200. **Racz A and Barsony J.** Hormone-dependent translocation of vitamin D receptors is linked to transactivation. *J Biol Chem* 274: 19352–19360, 1999.
201. **Rosen H, Reshef A, Maeda N, Lippoldt A, Shpizen S, Triger L, Eggertsen G, Bjorkheim I, and Leitersdorf E.** Markedly reduced bile acid synthesis but maintained levels of cholesterol and vitamin D metabolites in mice with disrupted sterol 27-hydroxylase gene. *J Biol Chem* 273: 14805–14812, 1998.
202. **Rost CR, Bikle DD, and Kaplan RA.** In vitro stimulation of 25-hydroxycholecalciferol 1 α -hydroxylation by parathyroid hormone in chick kidney slices: evidence for a role for adenosine 3',5'-monophosphate. *Endocrinology* 108: 1002–1006, 1981.
203. **Rowe PSN, Kumagai Y, Garrett R, Blacher R, Escobada A, and Mundy GR.** CHO-cells expressing MEPE, PHEX and co-expressing MEPE/PHEX cause major changes in BMD, P_i and serum alkaline phosphatase in nude mice (Abstract). *J Bone Miner Res* 17: S211, 2002.
204. **Saarem K, Bergseth S, Oftebro H, and Pedersen JL.** Subcellular localization of vitamin D₃ 25-hydroxylase in human liver. *J Biol Chem* 259: 10936–10940, 1984.
205. **Safadi F, Thornton P, Magiera H, Hollis B, Gentile M, Haddad J, Liebhaber S, and Cooke N.** Osteopathy and resistance to vitamin D toxicity in mice null for vitamin D binding protein. *J Clin Invest* 103: 239–251, 1999.
206. **Sanchez B, Lopez-Martin E, Segura C, Labandeira-Garcia JL, and Perez-Fernandez R.** 1,25-Dihydroxyvitamin D₃ increases striatal GDNF mRNA and protein expression in adult rats. *Brain Res Mol Brain Res* 108: 143–146, 2002.
207. **Sato T, Esteban L, and Dusso A.** Cell-specific regulation of C/EBP β expression and activation mediates PTH and γ -interferon induction of 1-hydroxylase gene transcription in murine renal cells and macrophages (Abstract). *J Am Soc Nephrol* 14: 685A, 2003.
208. **Sauer B, Ruwisch L, and Kleuser B.** Antiapoptotic action of 1 α ,25-dihydroxyvitamin D₃ in primary human melanocytes. *Melanoma Res* 13: 339–347, 2003.
209. **Schiavi SC and Kumar R.** The phosphatonin pathway: new insights in phosphate homeostasis. *Kidney Int* 65: 1–14, 2004.
210. **Schrader M, Kahlen JP, and Carlberg C.** Functional characterization of a novel type of 1 α ,25-dihydroxyvitamin D₃ response element identified in the mouse c-fos promoter. *Biochem Biophys Res Commun* 230: 646–651, 1997.
211. **Schwartz GG, Eads D, Rao A, Cramer SD, Willingham MC, Chen TC, Jamieson DP, Wang L, Burnstein KL, Holick MF, and Koumenis C.** Pancreatic cancer cells express 25-hydroxyvitamin D-1 α -hydroxylase and their proliferation is inhibited by the prohormone 25-hydroxyvitamin D₃. *Carcinogenesis* 25: 1015–1026, 2004.
212. **Schwartz GG, Whitlatch LW, Chen TC, Lokeshwar BL, and Holick MF.** Human prostate cells synthesize 1,25-dihydroxyvitamin D₃ from 25-hydroxyvitamin D₃. *Cancer Epidemiol Biomarkers Prev* 7: 391–395, 1998.
213. **Schwarz U, Amann K, Orth SR, Simonaviciene A, Wessels S, and Ritz E.** Effect of 1,25 (OH)₂ vitamin D₃ on glomerulosclerosis in subtotaly nephrectomized rats. *Kidney Int* 53: 1696–1705, 1998.
214. **Sela-Brown A, Russell J, Koszewski NJ, Michalak M, Naveh-Many T, and Silver J.** Calreticulin inhibits vitamin D's action on the PTH gene in vitro and may prevent vitamin D's effect in vivo in hypocalcemic rats. *Mol Endocrinol* 12: 1193–1200, 1998.
215. **Selles J, Massheimer V, Santillan G, Marinissen MJ, and Boland R.** Effects of calcitriol and its analogues, calcipotriol (MC 903) and 20-epi-1 α ,25-dihydroxyvitamin D₃ (MC 1288), on calcium influx and DNA synthesis in cultured muscle cells. *Biochem Pharmacol* 53: 1807–1814, 1997.
216. **Sergeev IN.** Calcium as a mediator of 1,25-dihydroxyvitamin D₃-induced apoptosis. *J Steroid Biochem Mol Biol* 89–90: 419–425, 2004.
217. **Shaffer PL and Gewirth DT.** Structural basis of VDR-DNA interactions on direct repeat response elements. *EMBO J* 21: 2242–2252, 2002.
218. **Shiizaki K, Hatamura I, Negi S, Narukawa N, Mizobuchi M, Sakaguchi T, Ooshima A, and Akizawa T.** Percutaneous maxacalcitol injection therapy regresses hyperplasia of parathyroid and induces apoptosis in uremia. *Kidney Int* 64: 992–1003, 2003.
219. **Shimada T, Urakawa I, Yamazaki Y, Hasegawa H, Hino R, Yoneya T, Takeuchi Y, Fujita T, Fukumoto S, and Yamashita T.** FGF-23 transgenic mice demonstrate hypophosphatemic rickets with reduced expression of sodium phosphate cotransporter type IIa. *Biochem Biophys Res Commun* 314: 409–414, 2004.
220. **Shinki T, Shimada H, Wakino S, Anazawa H, Hayashi M, Saruta T, DeLuca HF, and Suda T.** Cloning and expression of rat 25-hydroxyvitamin D₃-1 α -hydroxylase cDNA. *Proc Natl Acad Sci USA* 94: 12920–12925, 1997.
221. **Smith CL, Onate SA, Tsai MJ, and O'Malley BW.** CREB binding protein acts synergistically with steroid receptor coactivator-1 to enhance steroid receptor-dependent transcription. *Proc Natl Acad Sci USA* 93: 8884–8888, 1996.
222. **Song X, Bishop JE, Okamura WH, and Norman AW.** Stimulation of phosphorylation of mitogen-activated protein kinase by 1 α ,25-dihydroxyvitamin D₃ in promyelocytic NB4 leukemic cells: a structure-function study. *Endocrinology* 139: 457–465, 1998.
223. **Spach KM, Pedersen LB, Nashold FE, Kayo T, Yandell BS, Prolla TA, and Hayes CE.** Gene expression analysis suggests that 1,25-dihydroxyvitamin D₃ reverses experimental autoimmune encephalomyelitis by stimulating inflammatory cell apoptosis. *Physiol Genomics* 18: 141–151, 2004.
224. **St-Arnaud R, Arabian A, and Glorieux FH.** Abnormal bone development in mice deficient for the vitamin D-24-hydroxylase gene. *J Bone Miner Res* 11: S126, 1996.
225. **St-Arnaud R, Messerlian S, Moir JM, Omdahl JL, and Glorieux FH.** The 25-hydroxyvitamin D 1- α -hydroxylase gene maps to the pseudovitamin D-deficiency rickets (PDDR) disease locus. *J Bone Miner Res* 12: 1552–1559, 1997.
226. **St-Arnaud R, Arabian A, Travers R, Barletta F, Raval-Pandya M, Chapin K, Depovere J, Mathieu C, Christakos S, Demay MB, and Glorieux FH.** Deficient mineralization of intramembranous bone in vitamin D-24-hydroxylase-ablated mice is due to elevated 1,25-dihydroxyvitamin D and not to the absence of 24,25-dihydroxyvitamin D. *Endocrinology* 141: 2658–2666, 2000.
227. **Strugnell SA and Deluca HF.** The vitamin D receptor—structure and transcriptional activation. *Proc Soc Exp Biol Med* 215: 223–228, 1997.
228. **Sugimoto T, Ritter C, Ried I, Morrissey J, and Slatopolsky E.** Effect of 1,25-dihydroxyvitamin D₃ on cytosolic calcium in dispersed parathyroid cells. *Kidney Int* 33: 850–854, 1988.
229. **Sundaram S, Sea A, Feldman S, Strawbridge R, Hoopes PJ, Demidenko E, Binderup L, and Gewirtz DA.** The combination of a potent vitamin D₃ analog, EB 1089, with ionizing radiation reduces tumor growth and induces apoptosis of MCF-7 breast tumor xenografts in nude mice. *Clin Cancer Res* 9: 2350–2356, 2003.
230. **Sylvia VL, Schwartz Z, Ellis EB, Helm SH, Gomez R, Dean DD, and Boyan BD.** Nongenomic regulation of protein kinase C isoforms by the vitamin D metabolites 1 α ,25-(OH)₂D₃ and 24R,25-(OH)₂D₃. *J Cell Physiol* 167: 380–393, 1996.
231. **Takeda S, Yoshizawa T, Nagai Y, Yamato H, Fukumoto S, Sekine K, Kato S, Matsumoto T, and Fujita T.** Stimulation of osteoclast formation by 1,25-dihydroxyvitamin D requires its binding to vitamin D receptor (VDR) in osteoblastic cells: studies using VDR knockout mice. *Endocrinology* 140: 1005–1008, 1999.
232. **Takemoto F, Shinki T, Yokoyama K, Inokami T, Hara S, Yamada A, Kurokawa K, and Uchida S.** Gene expression of vitamin D hydroxylase and megalin in the remnant kidney of nephrectomized rats. *Kidney Int* 64: 414–420, 2003.
233. **Takeyama K, Kitanaka S, Sato T, Kobori M, Yanagisawa J, and Kato S.** 25-Hydroxyvitamin D₃ 1 α -hydroxylase and vitamin D synthesis. *Science* 277: 1827–1830, 1997.
234. **Takeyama KMK, Murayama A, and Kato S.** Interactions of VDR with co-regulators by new vitamin D analogs (Abstract). *J Bone Miner Res* 16: S433, 2001.

235. **Tanaka Y and Deluca HF.** The control of 25-hydroxyvitamin D metabolism by inorganic phosphorus. *Arch Biochem Biophys* 154: 566–574, 1973.
236. **Tangpricha V, Pearce EN, Chen TC, and Holick MF.** Vitamin D insufficiency among free-living healthy young adults. *Am J Med* 112: 659–662, 2002.
237. **Tokumoto M, Tsuruya K, Fukuda K, Kanai H, Kuroki S, and Hirakata H.** Reduced p21, p27 and vitamin D receptor in the nodular hyperplasia in patients with advanced secondary hyperparathyroidism. *Kidney Int* 62: 1196–1207, 2002.
238. **Trechsel U, Bonjour JP, and Fleisch H.** Regulation of the metabolism of 25-hydroxyvitamin D₃ in primary cultures of chick kidney cells. *J Clin Invest* 64: 206–217, 1979.
239. **Tsujikawa H, Kurotaki Y, Fujimori T, Fukuda K, and Nabeshima Y.** Klotho, a gene related to a syndrome resembling human premature aging, functions in a negative regulatory circuit of vitamin D endocrine system. *Mol Endocrinol* 17: 2393–2403, 2003.
240. **Uitterlinden AG, Fang Y, Van Meurs JB, Pols HA, and Van Leeuwen JP.** Genetics and biology of vitamin D receptor polymorphisms. *Gene* 338: 143–156, 2004.
241. **Uitterlinden AG, Fang Y, van Meurs JB, van Leeuwen H, and Pols HA.** Vitamin D receptor gene polymorphisms in relation to vitamin D-related disease states. *J Steroid Biochem Mol Biol* 89: 187–193, 2004.
242. **Valrance ME and Welsh J.** Breast cancer cell regulation by high-dose vitamin D compounds in the absence of nuclear vitamin D receptor. *J Steroid Biochem Mol Biol* 89–90: 221–225, 2004.
243. **Van Abel M, Hoenderop JG, van der Kemp AW, van Leeuwen JP, and Bindels RJ.** Regulation of the epithelial Ca²⁺ channels in small intestine as studied by quantitative mRNA detection. *Am J Physiol Gastrointest Liver Physiol* 285: G78–G85, 2003.
244. **Van Cromphaut SJ, Dewerchin M, Hoenderop JG, Stockmans I, Van Herck E, Kato S, Bindels RJ, Collen D, Carmeliet P, Bouillon R, and Carmeliet G.** Duodenal calcium absorption in vitamin D receptor-knockout mice: functional and molecular aspects. *Proc Natl Acad Sci USA* 98: 13324–13329, 2001.
245. **Vesely DL and Juan D.** Cation-dependent vitamin D activation of human renal cortical guanylate cyclase. *Am J Physiol Endocrinol Metab* 246: E115–E120, 1984.
246. **Vidal M, Ramana CV, and Dusso AS.** Stat1-vitamin D receptor interactions antagonize 1,25-dihydroxyvitamin D transcriptional activity and enhance stat1-mediated transcription. *Mol Cell Biol* 22: 2777–2787, 2002.
247. **Wagner N, Wagner KD, Schley G, Badiali L, Theres H, and Scholz H.** 1,25-Dihydroxyvitamin D₃-induced apoptosis of retinoblastoma cells is associated with reciprocal changes of Bcl-2 and bax. *Exp Eye Res* 77: 1–9, 2003.
248. **Whitfield GK, Remus LS, Jurutka PW, Zitzer H, Oza AK, Dang HT, Haussler CA, Galligan MA, Thatcher ML, Encinas Dominguez C, and Haussler MR.** Functionally relevant polymorphisms in the human nuclear vitamin D receptor gene. *Mol Cell Endocrinol* 177: 145–159, 2001.
249. **Wiese RJ, Umland-Smith A, Ross TK, Prahl JM, and DeLuca HF.** Up-regulation of the vitamin D receptor in response to 1,25-dihydroxyvitamin D₃ results from ligand-induced stabilization. *J Biol Chem* 267: 20082–20086, 1992.
250. **Wu J, Garami M, Cao L, Li Q, and Gardner DG.** 1,25(OH)₂D₃ suppresses expression and secretion of atrial natriuretic peptide from cardiac myocytes. *Am J Physiol Endocrinol Metab* 268: E1108–E1113, 1995.
251. **Wu J, Garami M, Cheng T, and Gardner DG.** 1,25(OH)₂ vitamin D₃ and retinoic acid antagonize endothelin-stimulated hypertrophy of neonatal rat cardiac myocytes. *J Clin Invest* 97: 1577–1588, 1996.
252. **Wu S, Finch J, Zhong M, Slatopolsky E, Grieff M, and Brown AJ.** Expression of the renal 25-hydroxyvitamin D-24-hydroxylase gene: regulation by dietary phosphate. *Am J Physiol Renal Physiol* 271: F203–F208, 1996.
253. **Yagci A, Werner A, Murer H, and Biber J.** Effect of rabbit duodenal mRNA on phosphate transport in *Xenopus laevis* oocytes: dependence on 1,25-dihydroxy-vitamin-D₃. *Pflügers Arch* 422: 211–216, 1992.
254. **Yamamoto H, Miyamoto K, Li B, Taketani Y, Kitano M, Inoue Y, Morita K, Pike JW, and Takeda E.** The caudal-related homeodomain protein Cdx-2 regulates vitamin D receptor gene expression in the small intestine. *J Bone Miner Res* 14: 240–247, 1999.
255. **Yamane T, Takeuchi K, Yamamoto Y, Li YH, Fujiwara M, Nishi K, Takahashi S, and Ohkubo I.** Legumain from bovine kidney: its purification, molecular cloning, immunohistochemical localization and degradation of annexin II and vitamin D-binding protein. *Biochim Biophys Acta* 1: 108–120, 2002.
256. **Yanagisawa J, Yanagi Y, Masuhiro Y, Suzawa M, Watanabe M, Kashiwagi K, Toriyabe T, Kawabata M, Miyazono K, and Kato S.** Convergence of transforming growth factor-beta and vitamin D signaling pathways on SMAD transcriptional coactivators. *Science* 283: 1317–1321, 1999.
257. **Yoshida T, Fujimori T, and Nabeshima Y.** Mediation of unusually high concentrations of 1,25-dihydroxyvitamin D in homozygous klotho mutant mice by increased expression of renal 1 α -hydroxylase gene. *Endocrinology* 143: 683–689, 2002.
258. **Yoshida T, Monkawa T, Tenenhouse HS, Goodyer P, Shinki T, Suda T, Wakino S, Hayashi M, and Saruta T.** Two novel 1 α -hydroxylase mutations in French-Canadians with vitamin D dependency rickets type II. *Kidney Int* 54: 1437–1443, 1998.
259. **Zahnow CA.** CCAAT/enhancer binding proteins in normal mammary development and breast cancer. *Breast Cancer Res* 4: 113–121, 2002.
260. **Zanello LP and Norman AW.** 1 α ,25(OH)₂-vitamin D₃-mediated stimulation of outward anionic currents in osteoblast-like ROS 17/2.8 cells. *Biochem Biophys Res Commun* 225: 551–556, 1996.
261. **Zanello LP and Norman AW.** Rapid modulation of osteoblast ion channel responses by 1 α ,25(OH)₂-vitamin D₃ requires the presence of a functional vitamin D nuclear receptor. *Proc Natl Acad Sci USA* 101: 1589–1594, 2003.
262. **Zhang C, Dowd DR, Staal A, Gu C, Lian JB, van Wijnen AJ, Stein GS, and MacDonald PN.** Nuclear coactivator-62 kDa/Ski-interacting protein is a nuclear matrix-associated coactivator that may couple vitamin D receptor-mediated transcription and RNA splicing. *J Biol Chem* 278: 35325–35336, 2003.
263. **Zhou LX, Nemere I, and Norman AW.** 1,25-Dihydroxyvitamin D₃ analog structure-function assessment of the rapid stimulation of intestinal calcium absorption (transcaltachia). *J Bone Min Res* 7: 457–463, 1992.
264. **Zhou LX and Norman AW.** 1 α ,25(OH)₂-vitamin D₃ analog structure-function assessment of intestinal nuclear receptor occupancy with induction of calbindin-D_{28K}. *Endocrinology* 136: 1145–1152, 1995.
265. **Zinser GM and Welsh J.** Accelerated mammary gland development during pregnancy and delayed postlactational involution in vitamin D₃ receptor null mice. *Mol Endocrinol* 18: 2208–2223, 2004.
266. **Zittermann A.** Vitamin D in preventive medicine: are we ignoring the evidence? *Br J Nutr* 89: 552–572, 2003.